



# Controllable Loads as a Resource

Understanding the Value Proposition across North American Power Markets

October 25, 2023

# The Energy Transition & Need for Flexible Resources

How do controllable loads help  
accelerate the renewables  
transition?



## Key Messages

---

- **To decarbonize energy means to electrify everything and simultaneously replace highly flexible fossil fuel generation with highly intermittent wind and solar (3X Demand, 15X Wind/Solar capacity)**
- **Replacing fossil fuel generation with intermittent wind and solar creates significant challenges for grid operators**
- **The grid of the future will need 4X more flexibility than it does today with batteries and demand response playing an oversized role (growing from 1% to 50%)**
- **Competitive wholesale and retail markets provide the greatest incentives for loads to provide flexibility**

# Net Zero Pathway Increases Power Demand via Electrification and Shifts Supply Towards Variable Renewables

Over the next 30 years, global electricity demand forecasted to 3X and renewables mix grows from 25% to 85%

**Global Electricity Demand (by Sector in the Net Zero Pathway)**

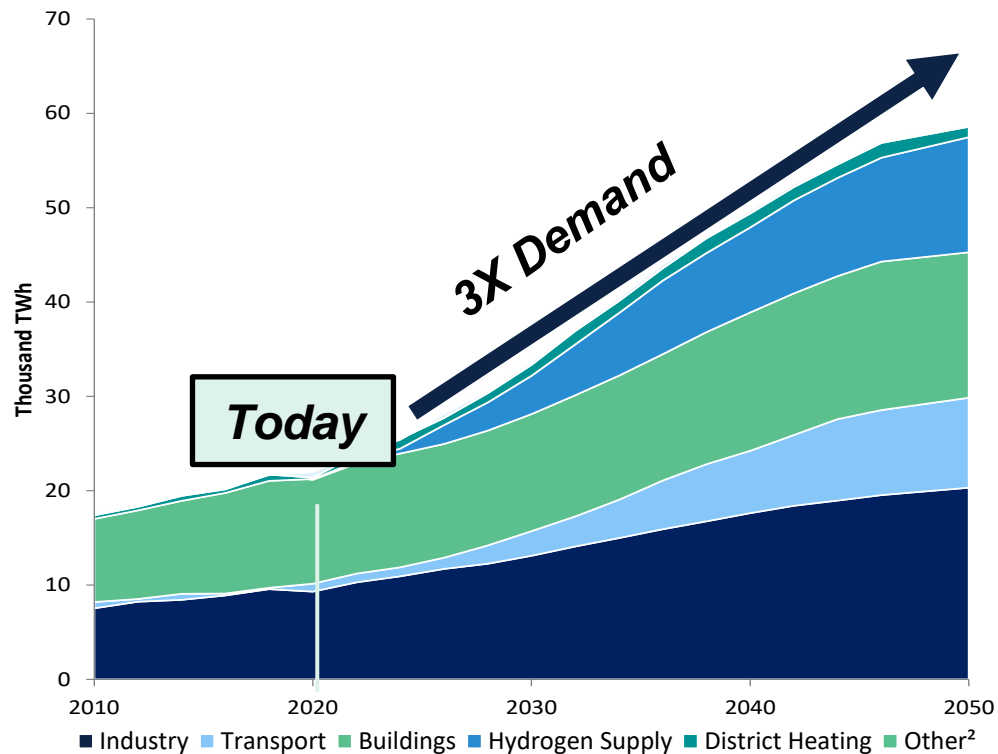

**Global Electricity Generation Mix (by Source in the Net Zero Scenario)**

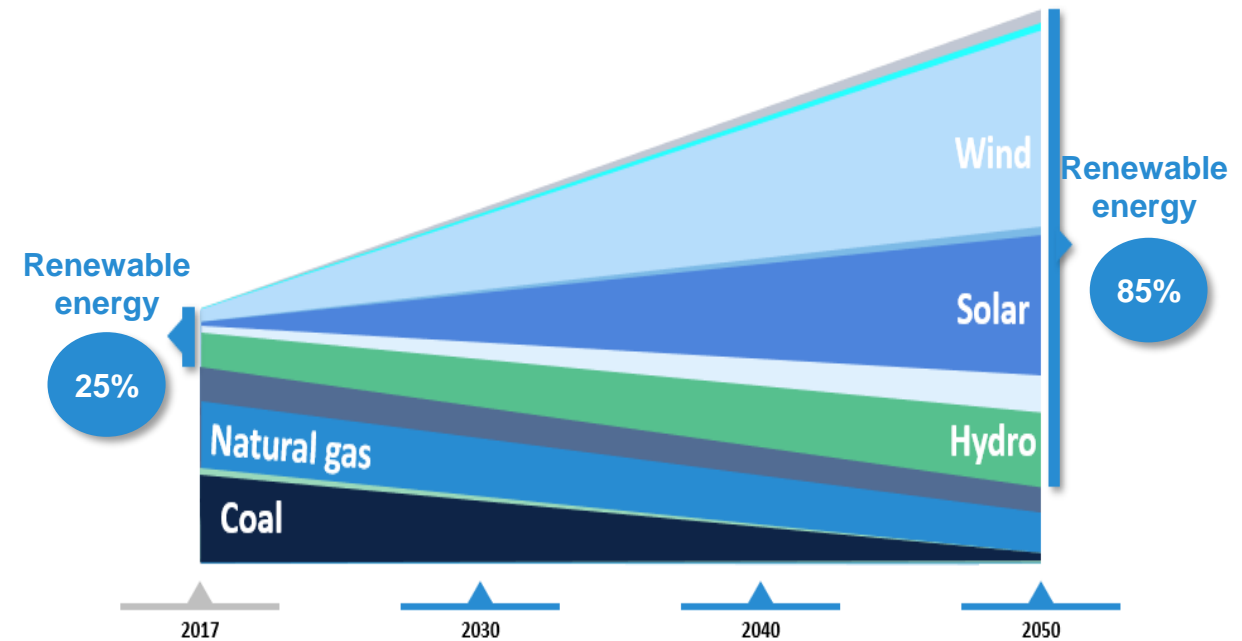

**Renewables will continue to take share from fossil fuels...**

# ....Causing Increased Prevalence of Negative Power Prices...

Depressed power prices can inhibit the buildout of new renewable generation

## Frequency of Negative Real-Time Pricing

2013



2021

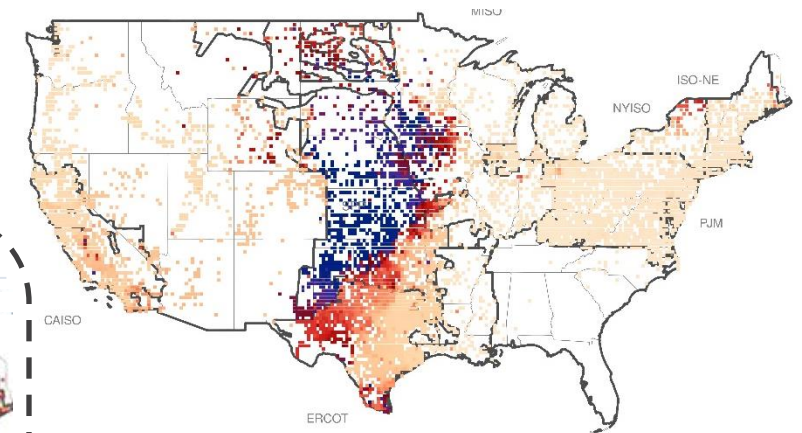

*Lancium founded*

2017

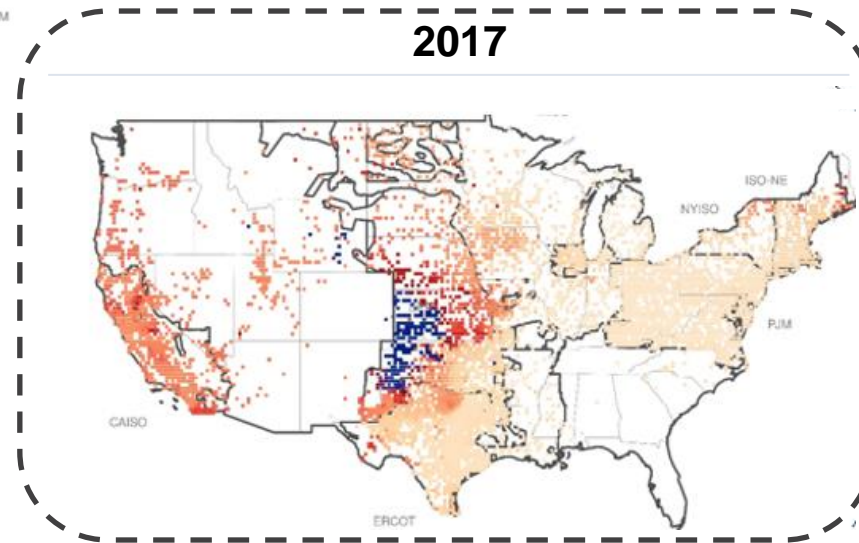

0%

10%

20%

# ...And Increased Intermittency on the Grid

Grid is being challenged to absorb rapid fluctuation in renewable generation

### Hourly Balancing Challenge for ERCOT – March 18, 2022 – March 20, 2022

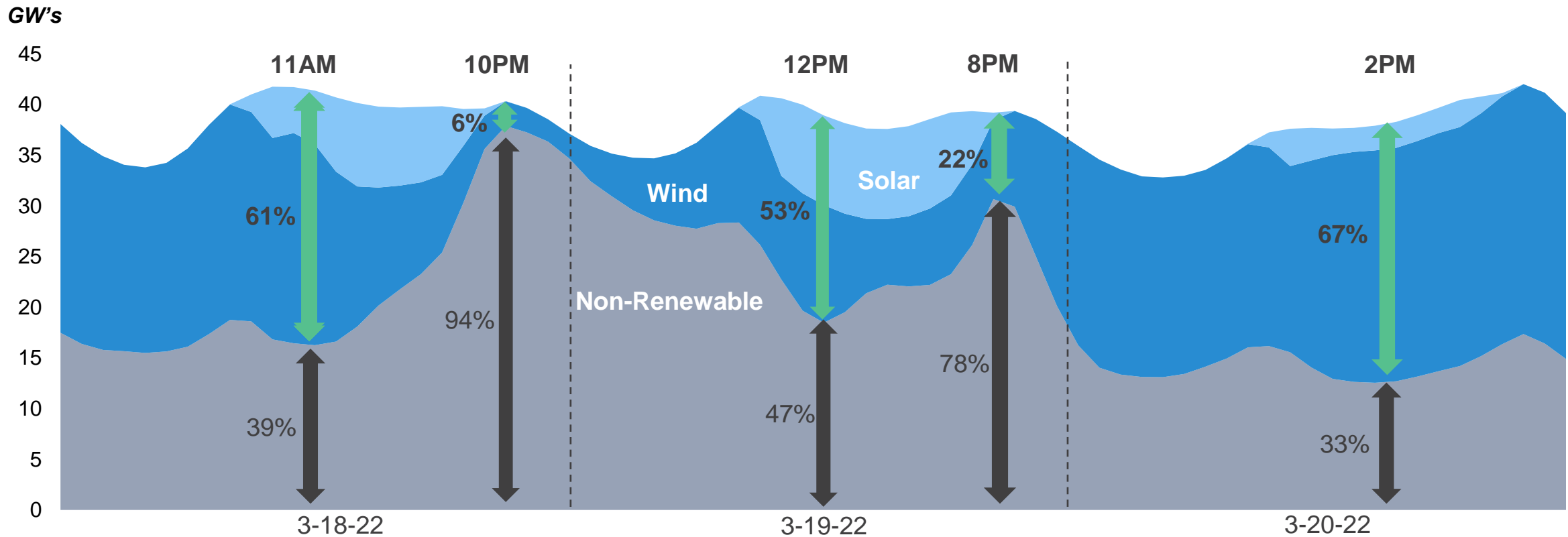

**Batteries and load flexibility can provide short-term balancing throughout the day**

- **A load is a resource when it can respond to signals or incentives from the grid to reduce its demand with the objective of reducing cost or maintaining reliability of the bulk power system**
- **A “Controllable Load Resource” (CLR) specifically can follow SCED base points and provide ancillary services**

# Price Response

Systematically control demand to turndown when \$/MWh power price is above \$/MWh breakeven

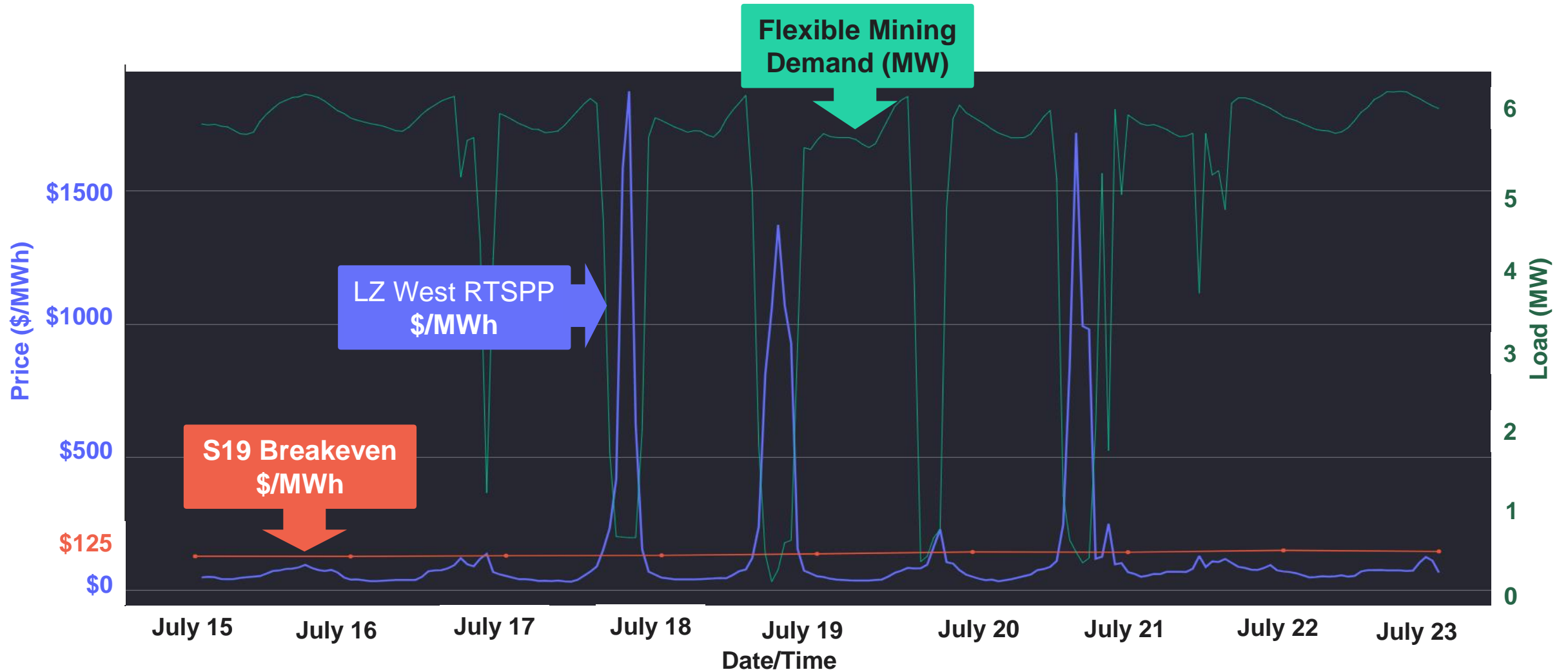



# Frequency Response

Automatically detect undesired grid frequency and power down load in seconds

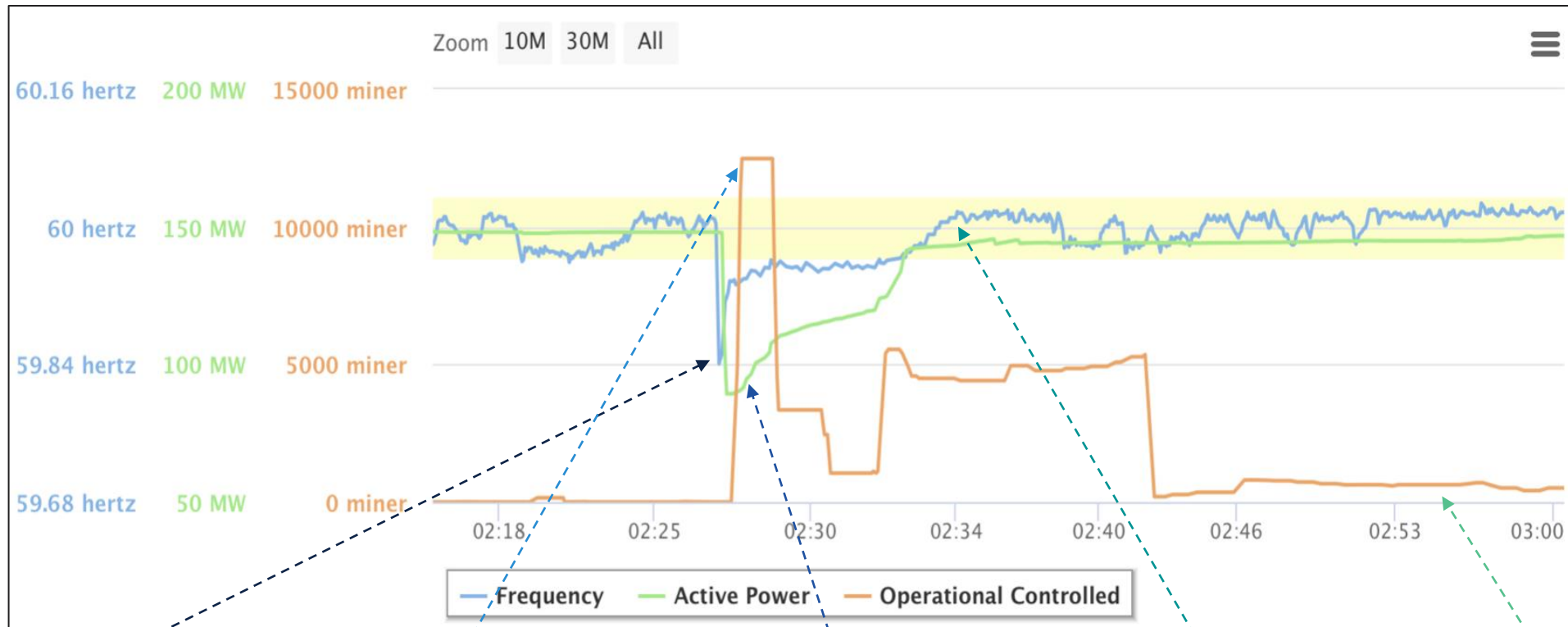

Grid frequency went down from 60 Hz to undesirable low level of 59.84 Hz

Smart Response™ detects the undesired frequency and power down more than 12,000 miners.

Active Power consumption is lowered from 150 MW to less than 100MW in seconds.

Frequency comes back to normal levels due to power consumption reduction.

Smart Response™ turns miners back on once frequency is reestablished.

# Evolution of the Controllable Load – 2017 to Present

**The Past (2017) – 2MW**  
Self Contained Portable Data Center



**The Present (2022) – 600MW**  
Permanent Structure Data Center – Rockdale, TX



**The Future (2024) ~1GW**  
Multi-End Market – Data Center, Batteries, Hydrogen



## Different Structures of Electricity Markets

How the controllable load value proposition differs across regions and market designs

## ISO/RTO Growth before 1996



# U.S Electricity Markets – Wholesale vs. Retail

Regulated vs Deregulated Markets

## Wholesale Electricity Markets

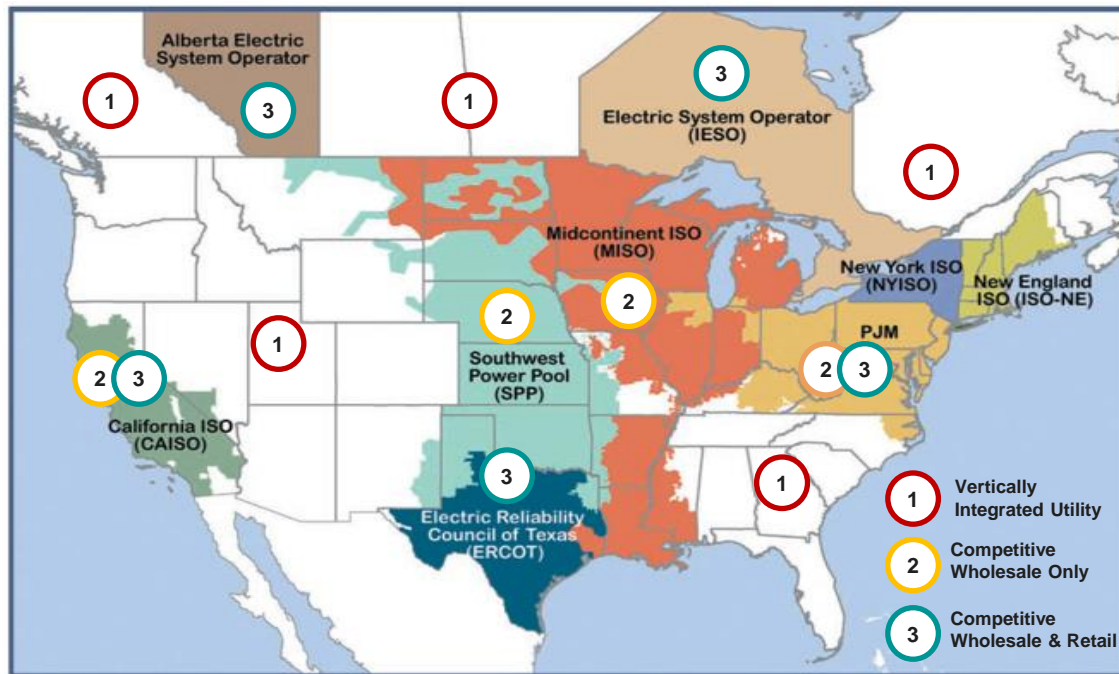

## Retail Choice Electricity Markets

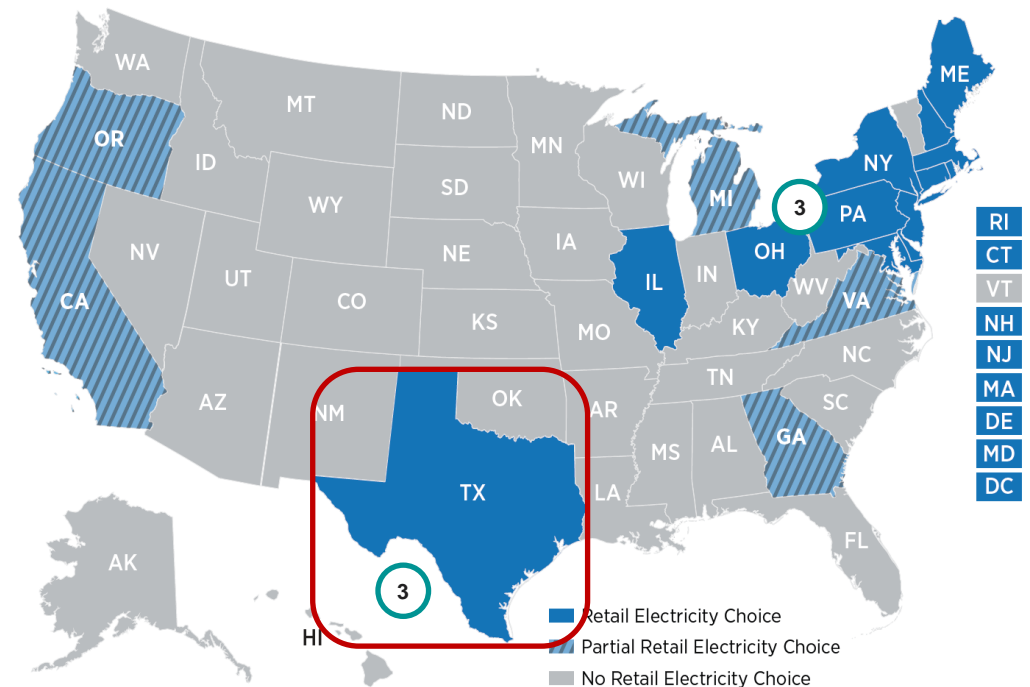

The value proposition of controllable loads is optimized for both system and load operators when loads are exposed to the wholesale market and able to earn revenue from ancillary services

# Different Structures of Electricity Markets

Regulated Monopoly

## Model 1 – Traditional Vertically Integrated Utility w/ Single Buyer

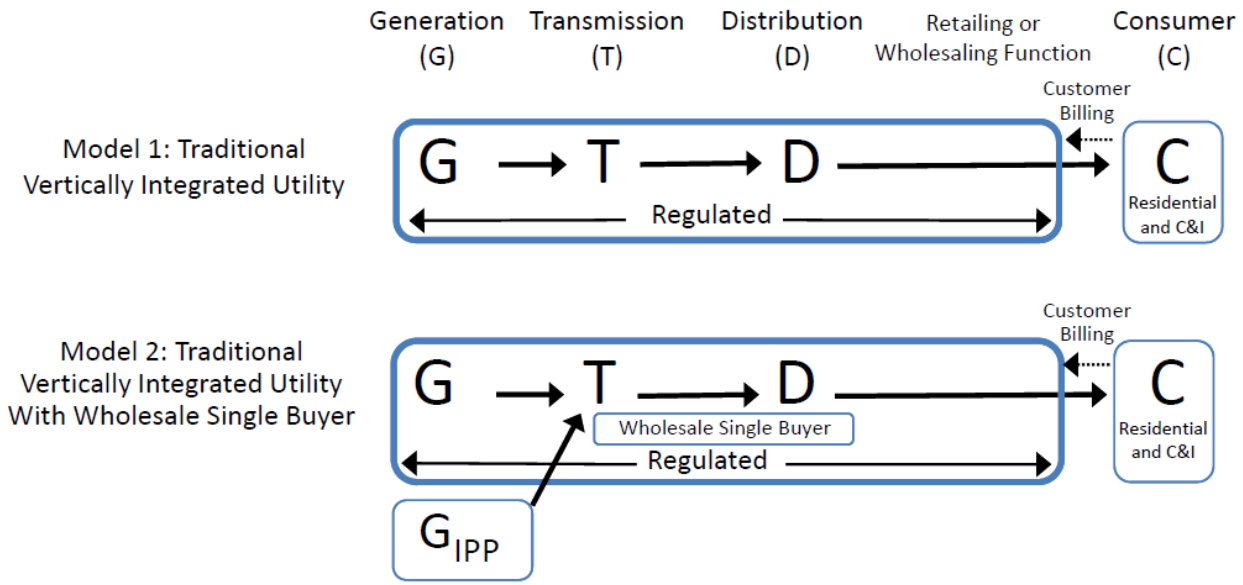

**Vertically Integrated Utilities**  
AKA - Monopoly, only game in town

The utility is the only game in town. The value of controllable load is that it is another customer for electricity, thus helping to amortize the cost of generation and transmission assets but is flexible enough to avoid the costs associated with increasing peak demand. Complicates integrated resource planning.

# Different Structures of Electricity Markets

Wholesale Competition with Regulated Retail

## Model 2 – Wholesale Competition (SPP, MISO)

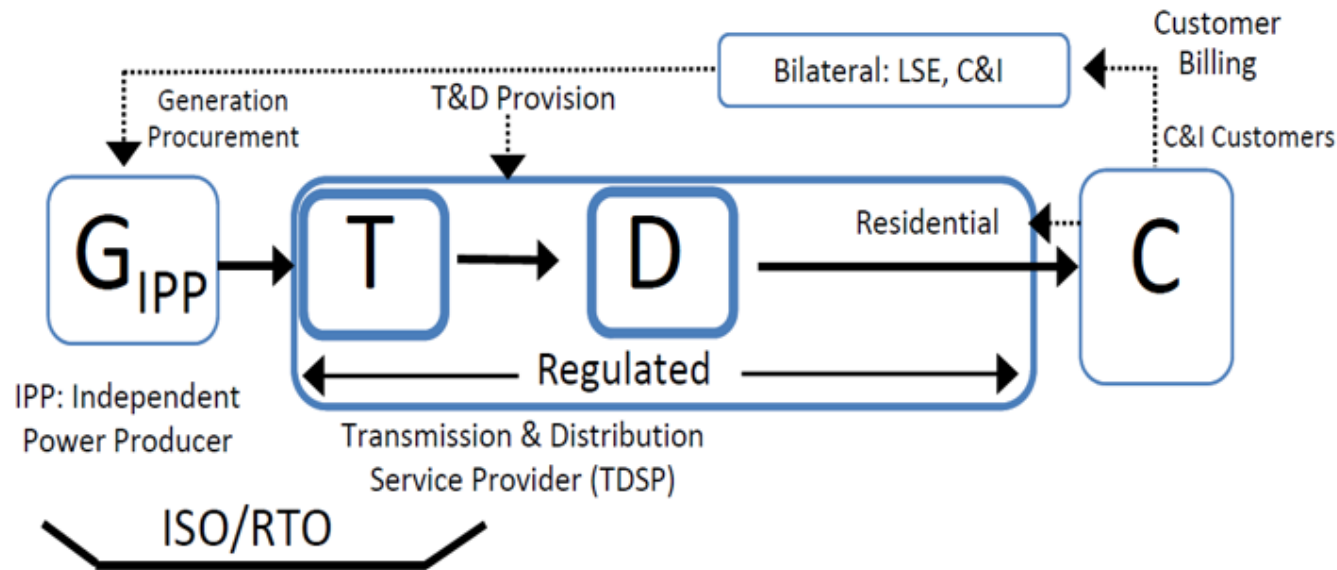

**Wholesale Competition w/ Regulated Retail**

The block contains the logos for the Southwest Power Pool (SPP) and the Midcontinent Independent System Operator (MISO). The SPP logo features a red and white circular icon followed by the text 'SPP Southwest Power Pool'. The MISO logo features a stylized sun and wave icon followed by the text 'MISO'.

In competitive markets, the grid operator acts as a clearing house for energy and ancillary services  
Flexible loads to participate in the energy and ancillary service markets – with the permission of the regulated utility and .  
Flexible loads have limited ability to monetize their flexibility or take advantage of variation in wholesale power prices.

# Different Structures of Electricity Markets – 20<sup>th</sup> Century Models

Competitive Wholesale & Retail Competition

## Model 3 – Wholesale & Retail Competition (i.e., ERCOT, AESO, PJM, NYISO, ISONE)

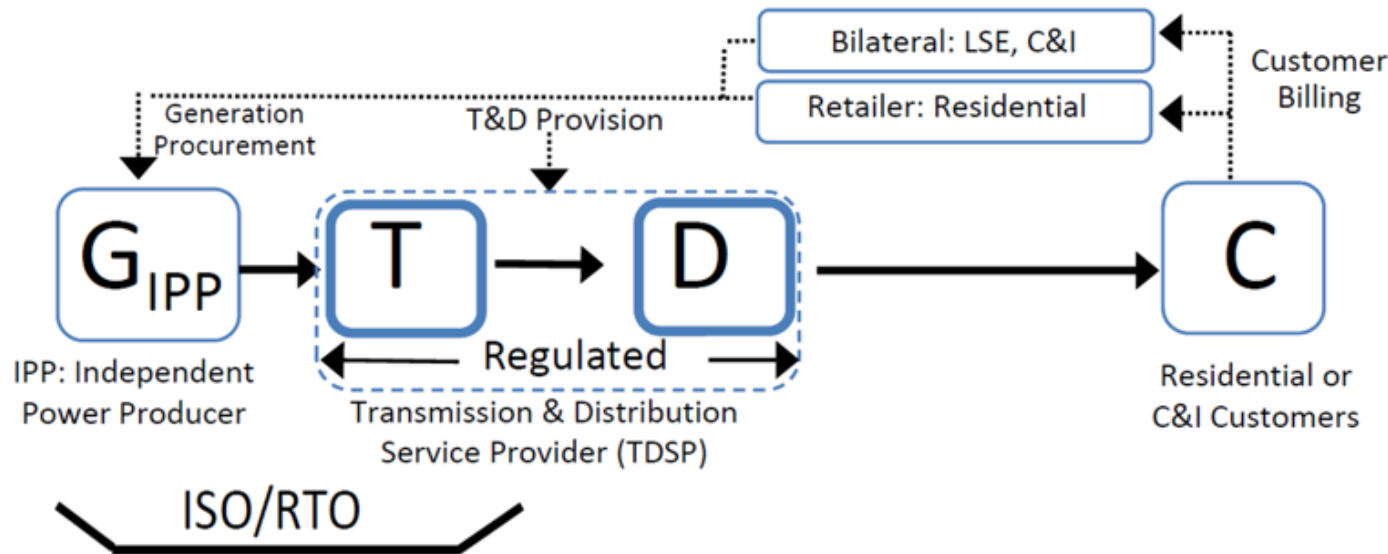

**Wholesale & Retail Competition**

New York ISO  
Independent System Operator

aeso

pjm

ercot

In these regions, flexible loads can compete freely in the competitive wholesale markets (energy, ancillary services) and is free to choose energy supplier, thus maximizing the value to both the system and load operators

# U.S Electricity Markets – Wholesale vs. Retail

Regulated vs Deregulated Markets

## Wholesale Electricity Markets

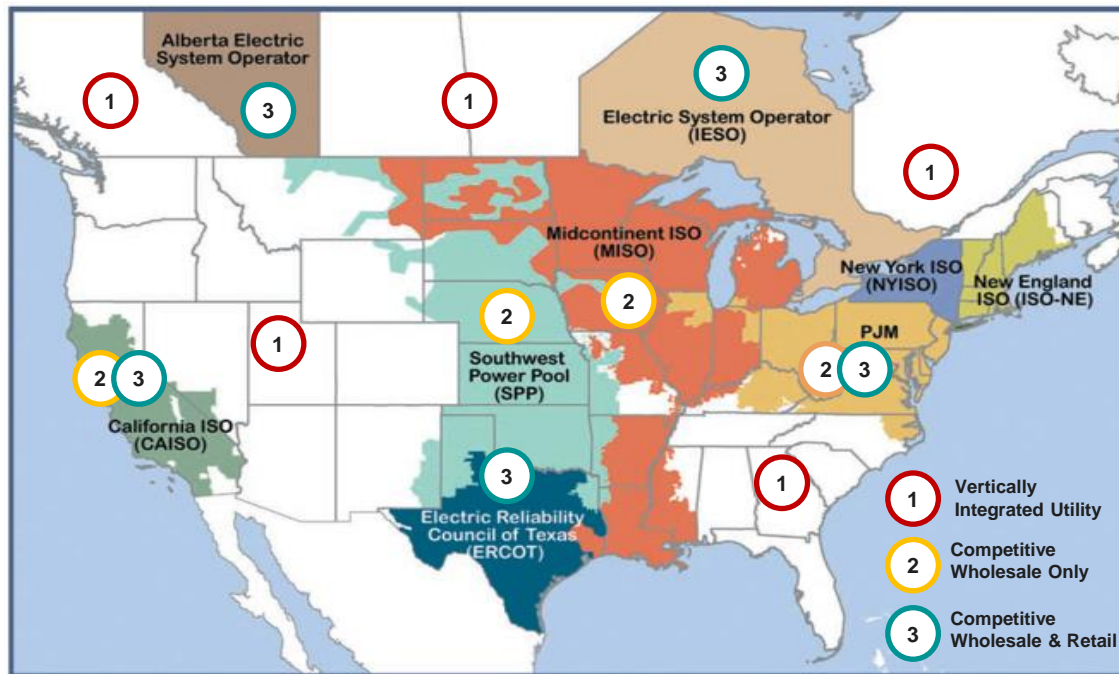

## Retail Choice Electricity Markets

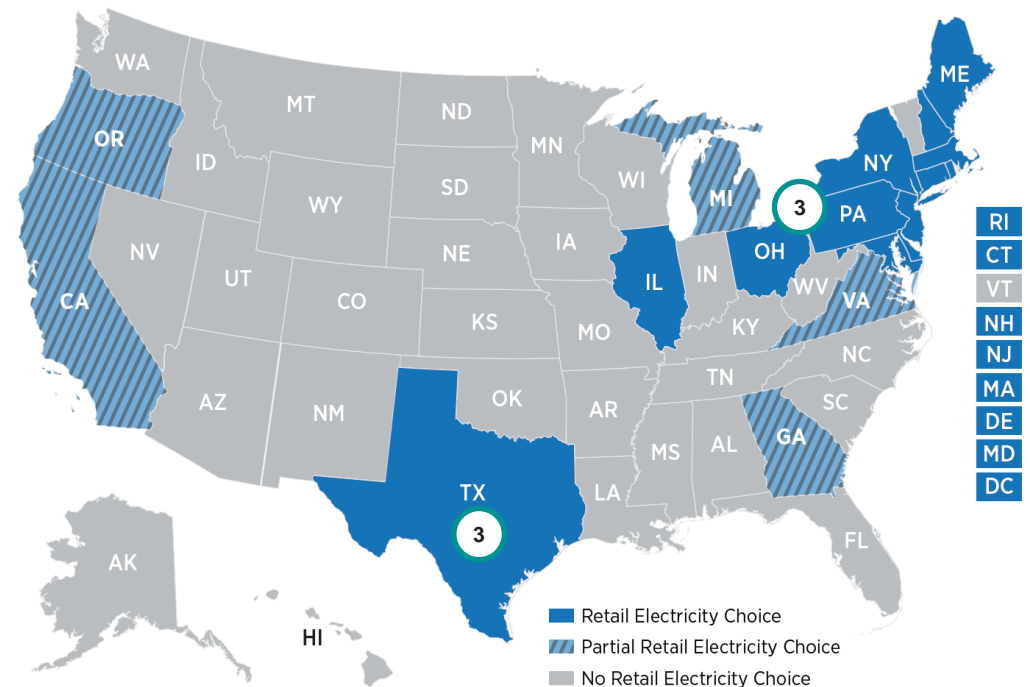

Controllable loads can best monetize their resource flexibility in (1) competitive wholesale markets and (2) competitive retail markets where they are free to choose their energy supplier



- **To decarbonize energy means to electrify everything and simultaneously replace highly flexible fossil fuel generation with highly intermittent wind and solar**
- **Controllable loads can play a major role in balancing supply and demand with a high penetration of intermittent generation**
- **The value proposition of controllable loads is optimized for both system and load operators when loads are exposed to the wholesale market and able to earn revenue from ancillary services**