



# PG&E EPIC 2.05 Synthetic Inertia Project Summary

---

Presenters: V. Gevorgian, Y. Zhang

NREL team: P. Koralewicz, H. Jain, J. Tan, H. Yuan

ESIG Spring Workshop

Albuquerque, NM

March 21, 2019



# Value of EPIC to PG&E & California State Policy Objectives

## Our Mission

To safely and reliably deliver affordable and clean energy to our customers and communities every single day, while building the energy network of tomorrow.

## EPIC Furthers PG&E's Mission

EPIC helps PG&E build the energy network of tomorrow through the demonstration of new and novel technologies that modernize and optimize the grid, and enables Distributed Energy Resource (DER) Integration and new customer offerings to ultimately improve safety, reliability and affordability for our customers

Invest in  
a sustainable  
energy future



## EPIC Advances CA Clean Energy Policy Objectives

EPIC allows IOUs to learn about and demonstrate technologies and systems needed to support resiliency plans and high-DER grid

Affordability and  
maximizing value for  
our Customers



## EPIC Establishes Low Cost / Risk, High Value Learnings

- Okay to try new things, "fail fast"
- If technology proves beneficial, streamlines Path-to-Production

# Objective and Motivation of PG&E EPIC 2.05 Project

- Concerns about reliability impacts in low inertia grids
- Full understanding of challenges and benefits of obtaining Synthetic Inertia (SI) support by inverter-coupled resources
- Two primary objectives:
  - Validate capabilities of utility-scale BESS to provide inertial and other APC-related services via PHIL demonstration
  - Quantify the benefits of SI to the PG&E grid by conducting simulation study for US Western Interconnection

# NWTC Controllable Grid Platform

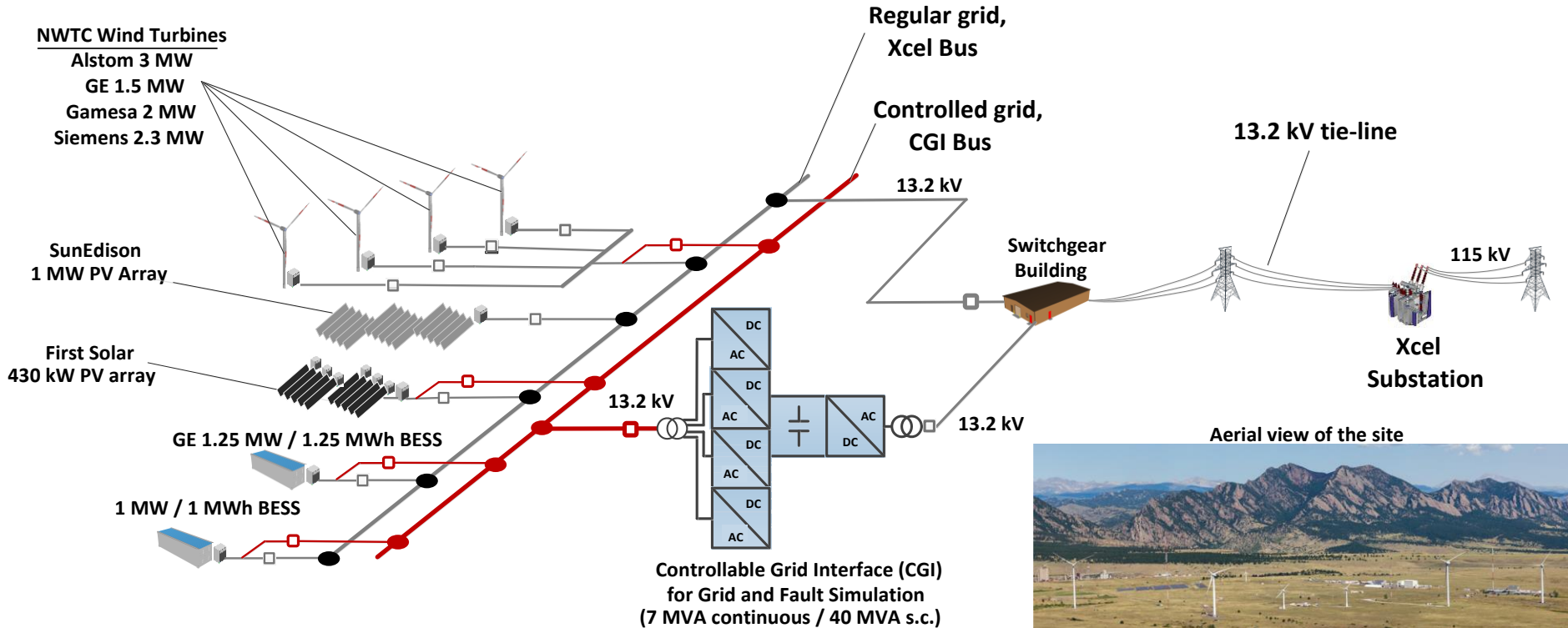

# Test Equipment

## Controllable Grid Interface (CGI)

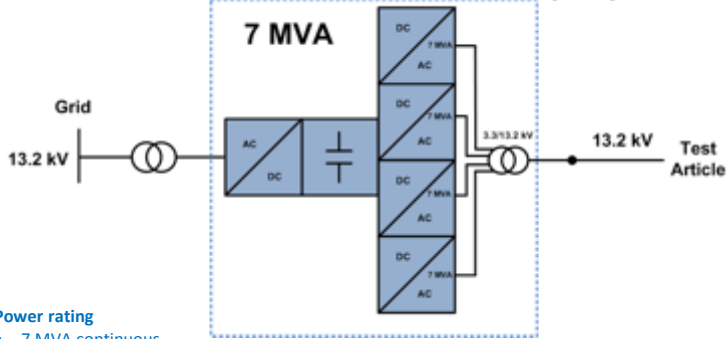

### Power rating

- 7 MVA continuous
- 39 MVA short circuit capacity (for 2 sec)
- 4-wire, 13.2 kV

### Possible test articles

- Types 1, 2, 3 and 4 wind turbines
- Capable of fault testing of largest Type 3 wind turbines
- PV inverters, energy storage systems
- Conventional generators
- Combinations of technologies

### Voltage control (no load THD <3%)

- Balanced and un-balanced voltage fault conditions (ZVRT and 130% HVRT) – independent voltage control for each phase on 13.2 kV terminals
- Response time – 1 millisecond (from full voltage to zero, or from zero back to full voltage)
- Long-term symmetrical voltage variations (+/- 10%) and voltage magnitude modulations (0-10 Hz) – SSR conditions
- Programmable impedance (strong and weak grids)
- Programmable distortions (lower harmonics 3, 5, 7)

### Frequency control

- Fast output frequency control (3 Hz/sec) within 45-65 Hz range
- 50/60 Hz operation
- Can simulate frequency conditions for any type of power system
- PHIL capable (coupled with RTDS, Opal-RT, etc.)

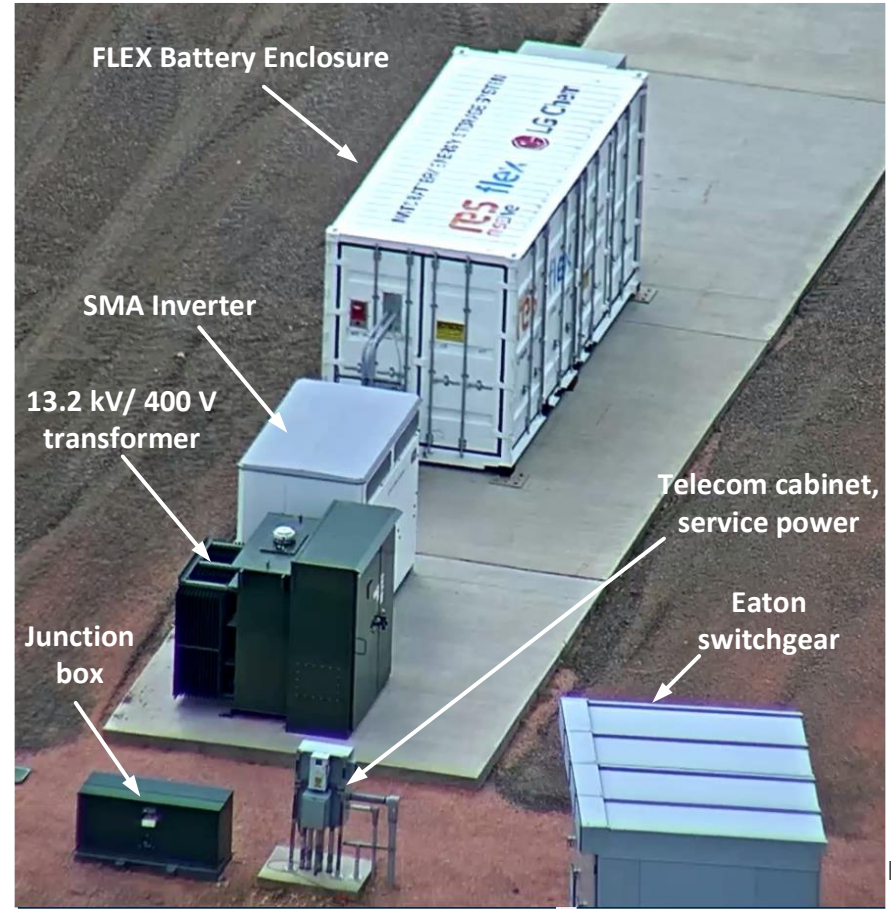

# BESS P-Q Control Diagram

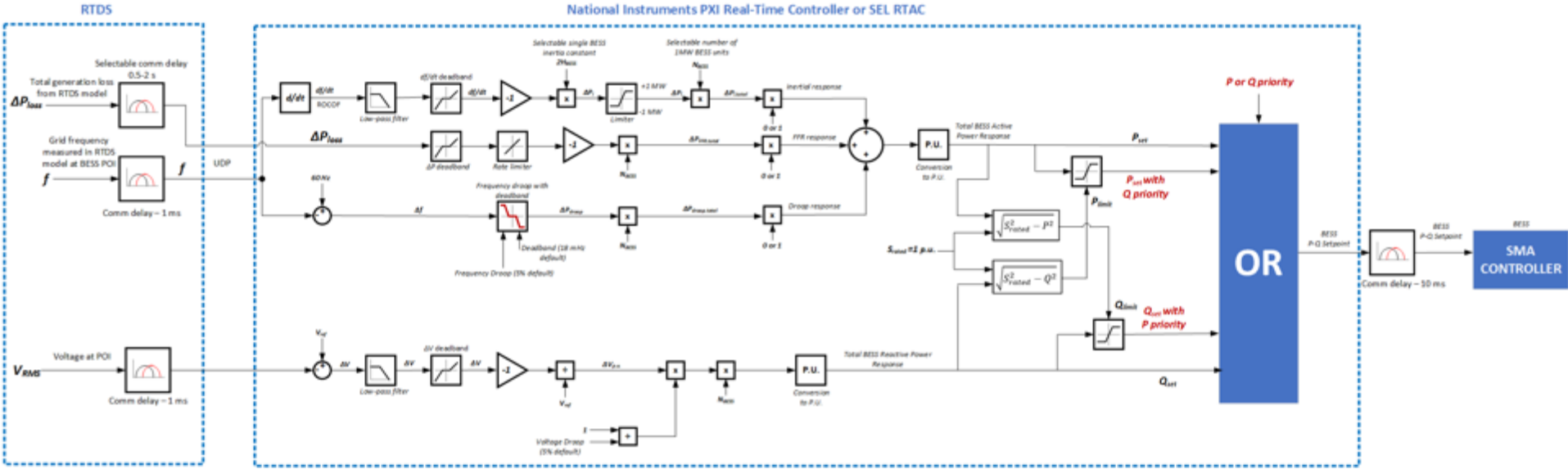

Inertia      FFR      Droop      AGC

$$P_{bess}(t) = P_o(t) - 2H \frac{df(t)}{dt} + \Delta P_{FFR}(t) - \frac{f_o - f(t)}{droop} + \Delta P_{AGC}(t)$$

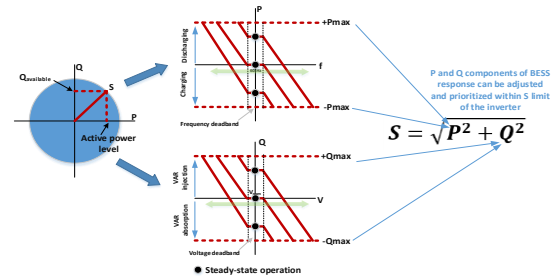

# NREL RTAC Interface for BESS control

BESS Supervisory controller developed in Q2

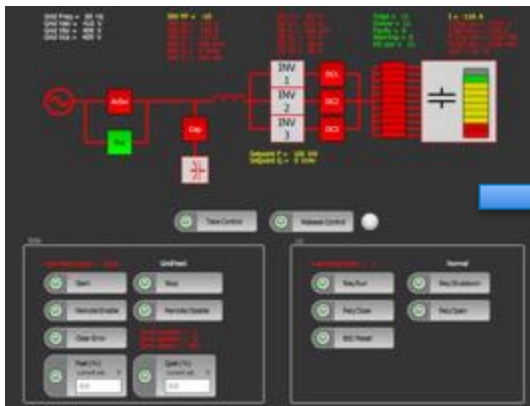

BESS Grid Service controller developed in Q3

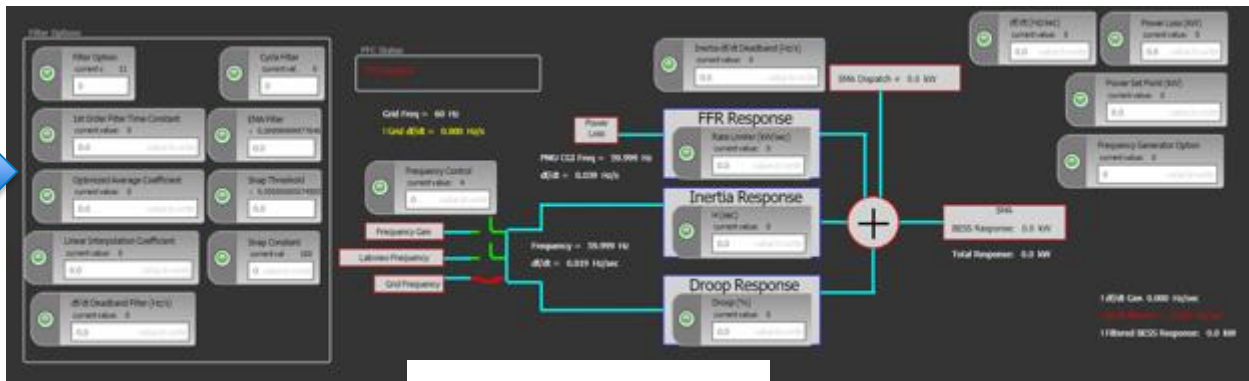

- The new controller developed by the team is deployed on a standard substation real-time automation equipment (SEL RTAC).
- This opens a path for easy commercialization and wide-scale adoption for this new BESS controller concept, and also makes it easy to integrate with the FS PV plant controller.
- Achieving less than **20-30 millisecond** response time is a significant accomplishment in the area of BESS control systems.

2018\_07\_17\_15\_23\_57\_PQ\_F17\_SMA\_PQ\_STEPS 0 to\_p1000\_newFWtdms

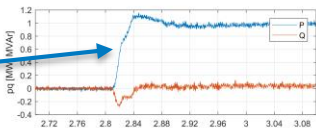
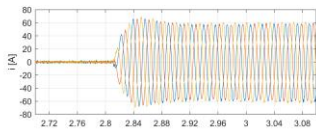
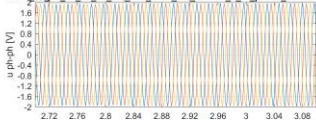

# CGI and PHIL Interface

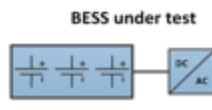
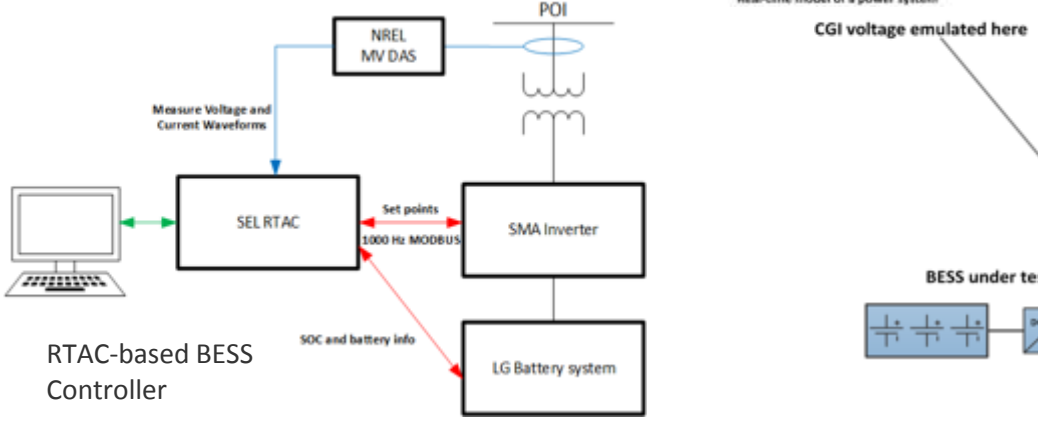
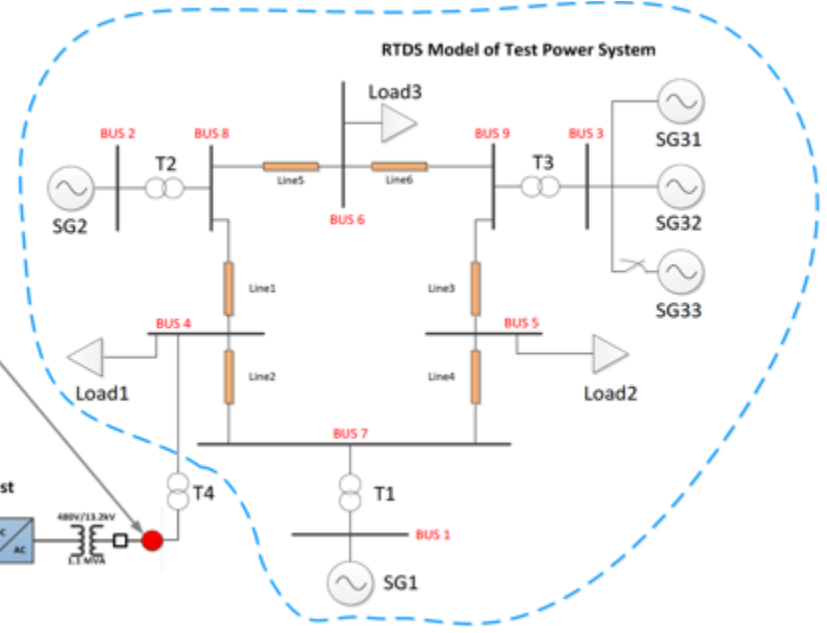
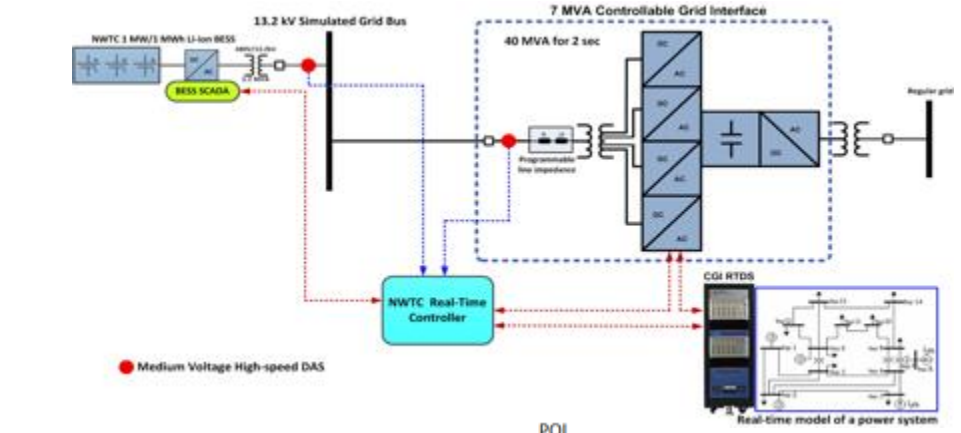
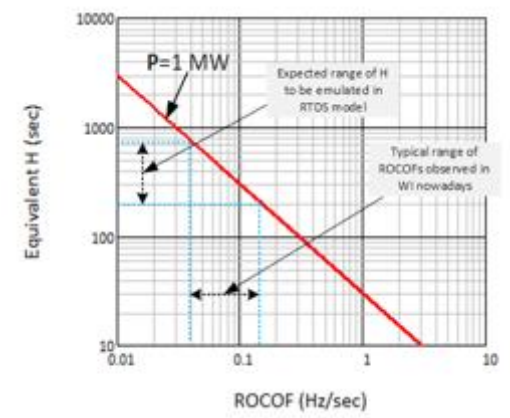



# PSCAD Model of Adopted 9-bus System

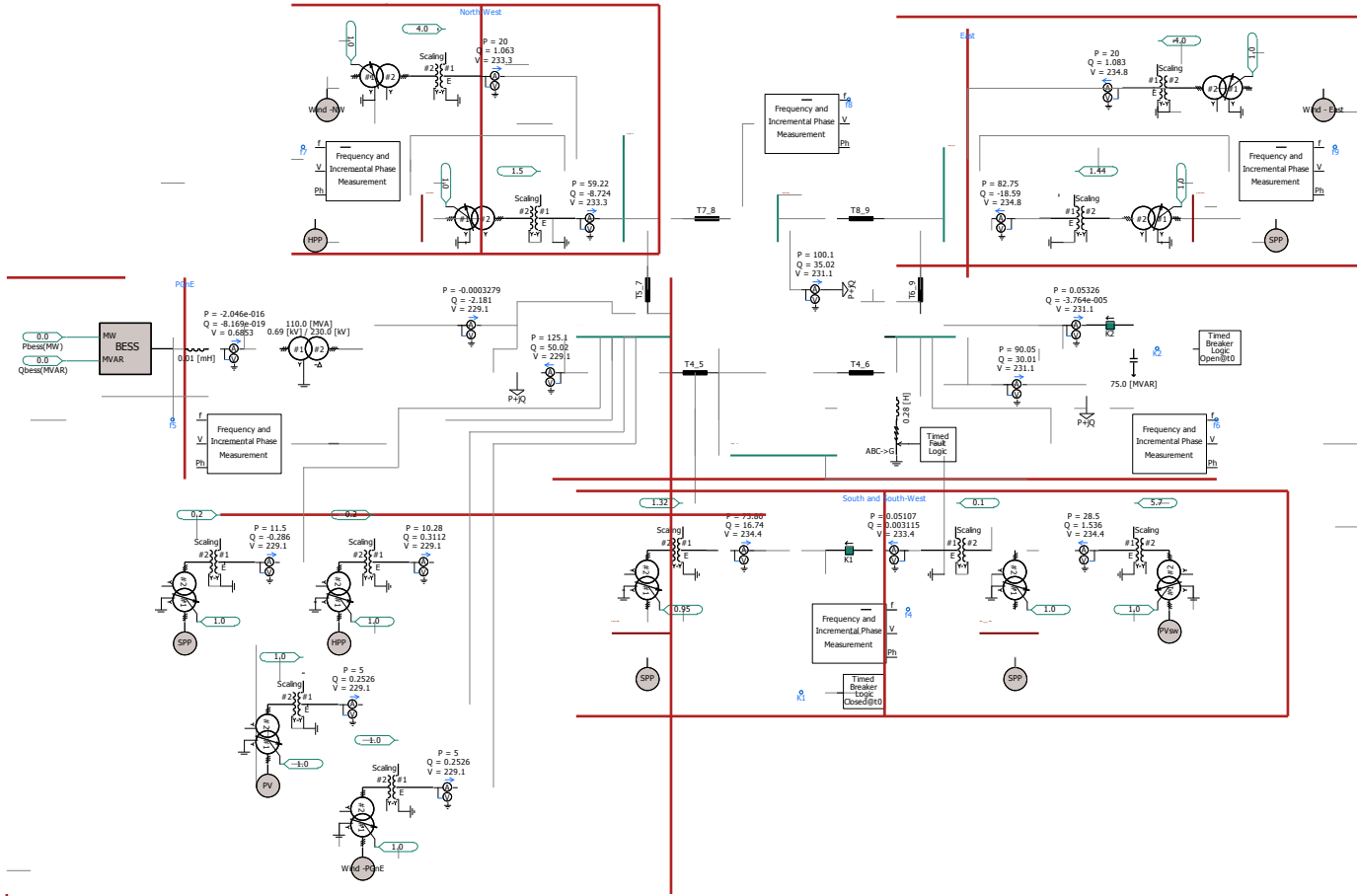

# Renewable Penetration Scenarios for PHIL System

Renewable penetration	Conventional Generators			PV & Wind	Loads	Total H
	$P_{Gn}$ GW	$H_G$ sec	$P_{Gdispatch}$ GW	$P_{Rn}$ , GW	$P_L$ GW	$H_{Tot}$ sec
60%	53.3	4	40	60	100	2.13
40%	80	4	60	40	100	3.20
20%	106.7	4	80	20	100	4.27
15%	113.3	4	85	15	100	4.53
0%	133.3	4	100	0	100	5.33

## Inertia scaling

Renewables Penetration (%)	$H_{Total}$ sec	$H_{BESS}$ sec
0	5.33	125
15	4.53	106
20	4.27	100
40	3.20	75
60	2.13	50

- BESS H was adjusted to ensure that we are getting the same maximum benefit from BESS at any penetration level in terms of active power response.
- For smaller H, the BESS will produce less power than it is capable of, and therefore, the comparison between cases will not be correct.

# Inertia or FFR?

## Inertia only

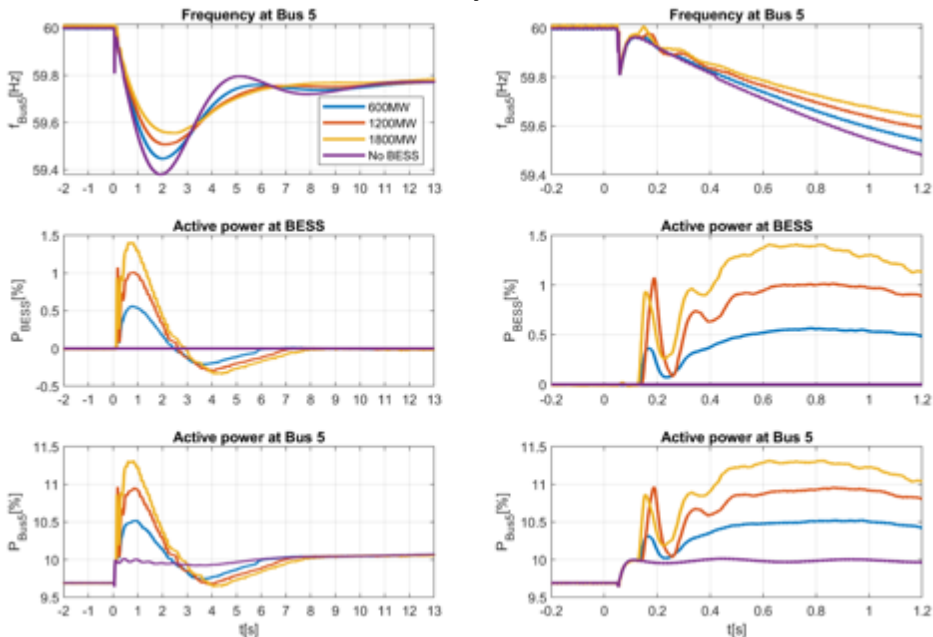

## FFR only

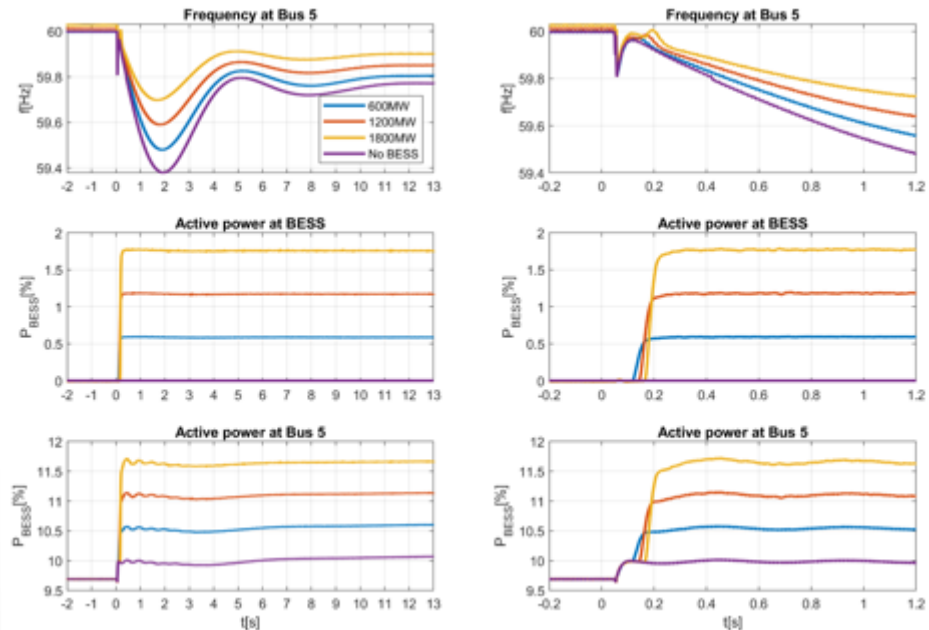

# Comparison of BESS Control Impacts

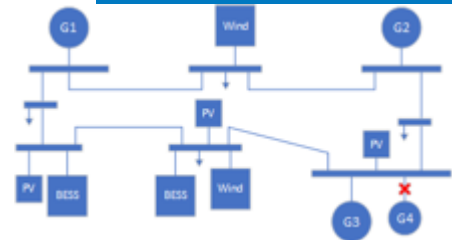

System frequency (a) and BESS response (b)

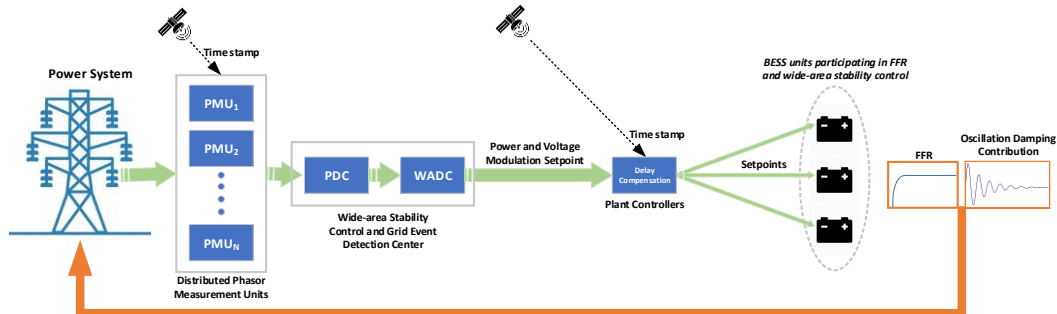
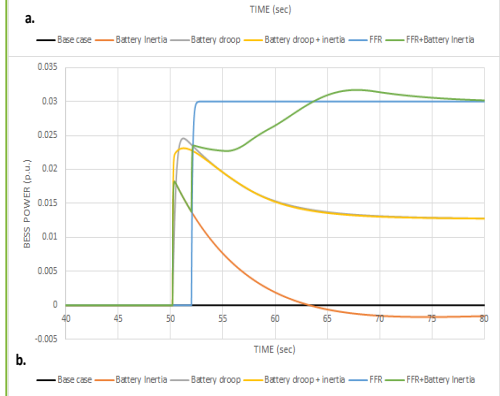
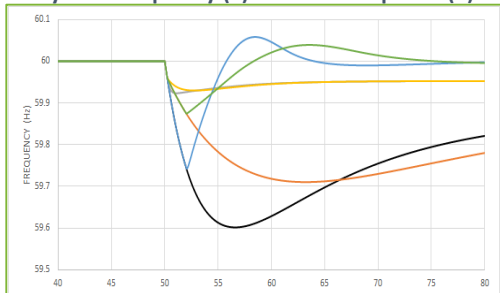

System frequency at 30% case

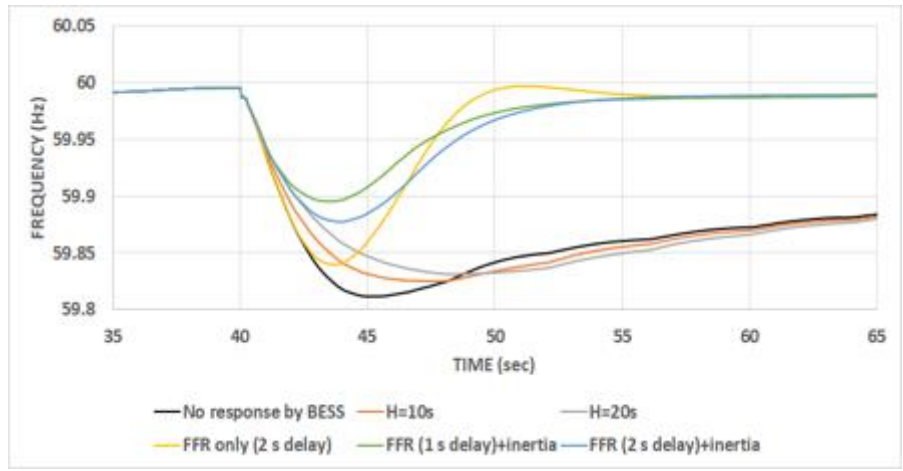

# Distribution System Testbed for Islanded Testing

## Grid Forming Control

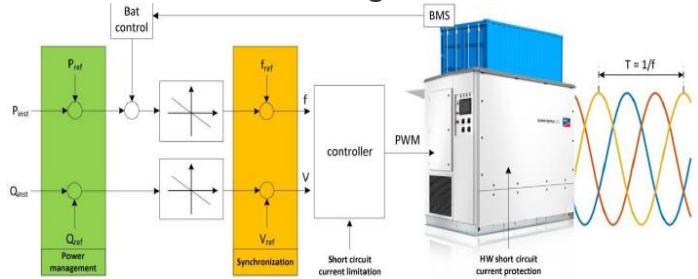

## 7 MVA Controllable Grid Interface

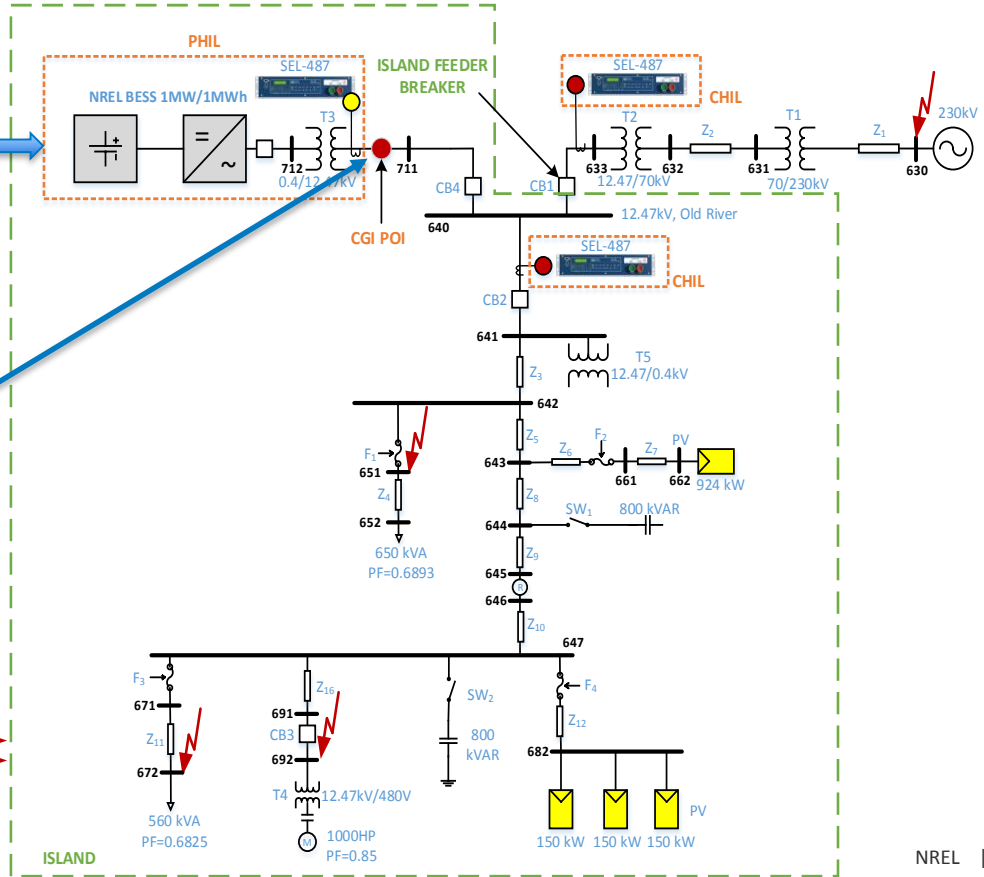
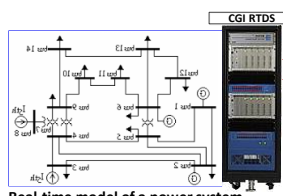
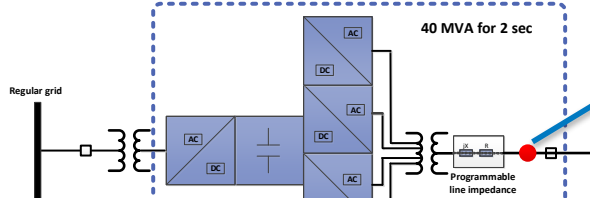

# PHIL Task Conclusions

- PHIL testing of inverters under realistic voltage conditions is an important step in understanding their true dynamic and transient performance. Even though vendors claim compliance with certain standards, the true performance of inverters will depend on many factors missed during certification testing.
- New inverter testing standards and utility interconnection requirements are needed for increasingly demanding (low inertia) future grid scenarios.
- Frequency responsive contributions by BESS inverters are highly dependent on their location in grid
- An ensemble of controls approaches demonstrated superior performance and may lead to the best solution for future needs:
  - SIR (Synthetic Inertia Response) i.e. differential (ROCOF based), studied here
  - FFR (Fast Frequency Response) i.e. step change output, perhaps based on system-level monitoring and control, or designed like an UFLS scheme
  - PFR (Primary Frequency Response) i.e. proportional (frequency droop) control

# Objectives for the simulation and validation

**Key Question** – How do Synthetic Inertia (SI) controls on Inverter-based Generation Resources (IRGs) impact the PG&E power system in a high renewable future?

## **Five Main Tasks:**

- Understanding the state-of-the art of SI control
- Developing a SI controller model in PSLF based on the model developed in the PHIL workstream
- obtaining the IRG penetration threshold in the PGE territory *w/o* SI
- obtaining the IRG penetration threshold in the PGE territory *w/* SI
- Provide recommendations on SI performance requirements and deployment

# SI Controller Model in PSLF

- The actual SI model included low pass filters to attenuate high frequency spikes

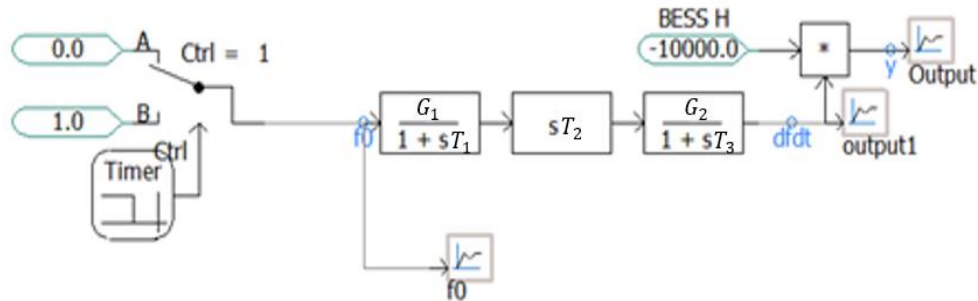

- SI controller output was added to the  $P_{ref}$  input of the  $reec_b(c)$  models

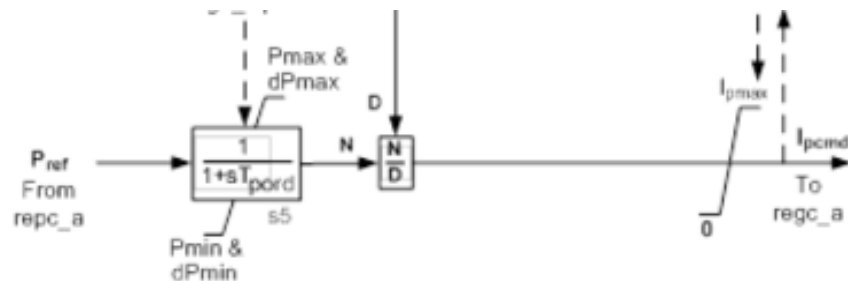



# Validation of the PSLF SI Controller Model

- Identical SI controller model and almost identical WECC 9-bus system models were created in PSLF and PSCAD to validate the PSLF SI controller model
- **Open Loop Test** – Step response of SI controller in PSLF and PSCAD
- **Close Loop Test** – Hardware-in-the-Loop Test using RTDS with SI controller added to a BESS

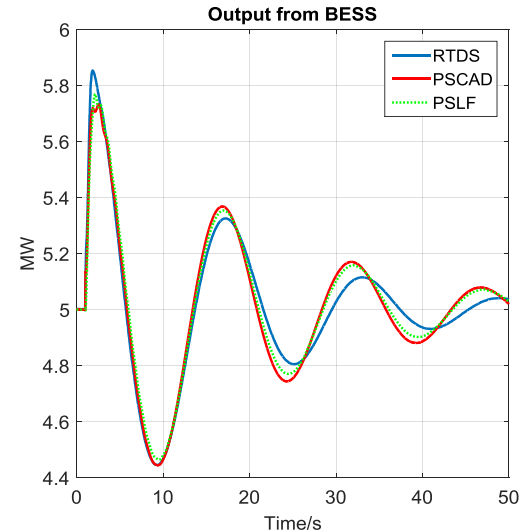
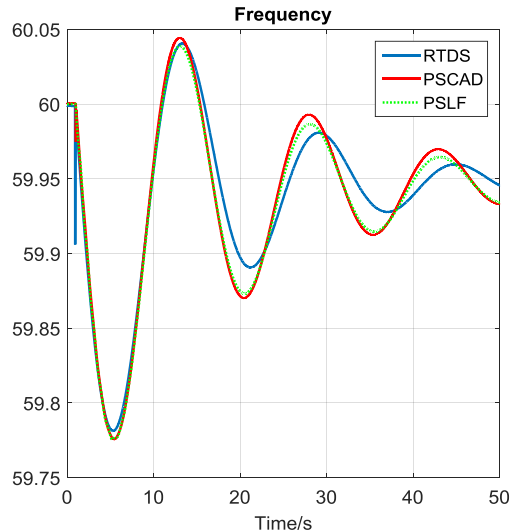
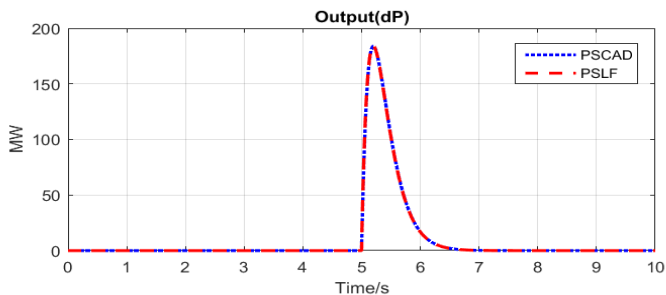
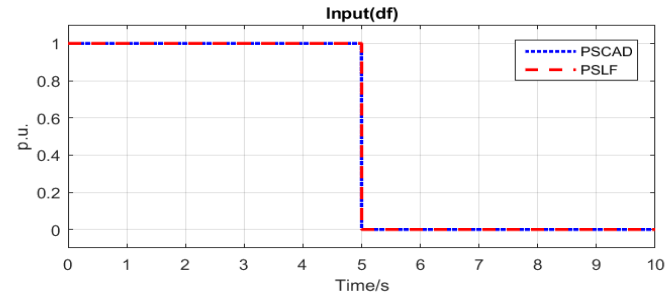

# IRG Threshold – No SI

- *Near zero inertia case* was first created to determine if the WECC power system can accommodate this IRG level without violating the dynamic performance criteria.
  - ✓ This case had 88% of positive generation dispatch from IRGs
  - ✓ Over 1,000 59.6 Hz criterion violations were observed, but the system did not become unstable
- Since the near zero inertia case showed dynamic performance criteria violations, we started reducing the IRG penetration level till no dynamic performance criteria violations were observed.
  - ✓ This limit was found to be around **10,000 MW of IRG** dispatch in PGE or around **57%** of the total positive generation in PGE

# Comparison of PV with and w/o SI

- Event:P\_EXT\_0

The summary of frequency violation

		violations of WECC Frequency Deviation criteria 59.6Hz		violations of WECC Frequency Deviation criteria 59.0Hz		Lowest frequency (Hz)	
		No_SI	SI	No_SI	SI	No_SI	SI
<b>6</b>	10000 MW case	0	0	0	0	59.72	59.74

- SI can improve the frequency nadir;
- SI can reduce the ROCOF;
- SI can not improve the settling frequency;
- No violation even in the 16000 MW IRG in PG&E case

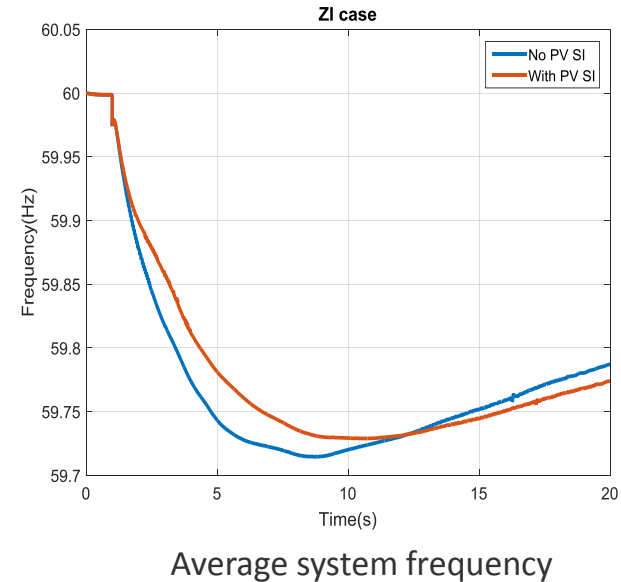

# Comparison of PV with and w/o SI

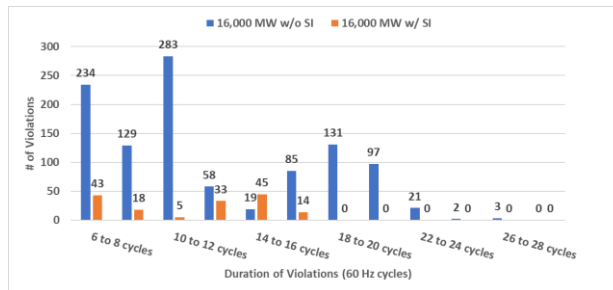
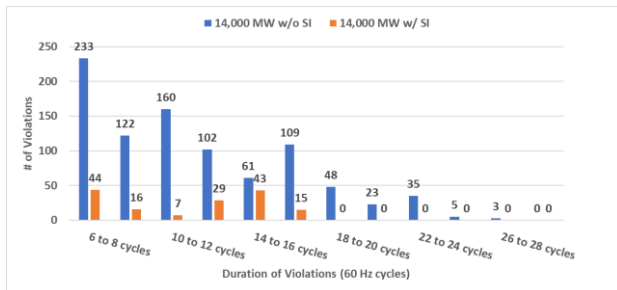
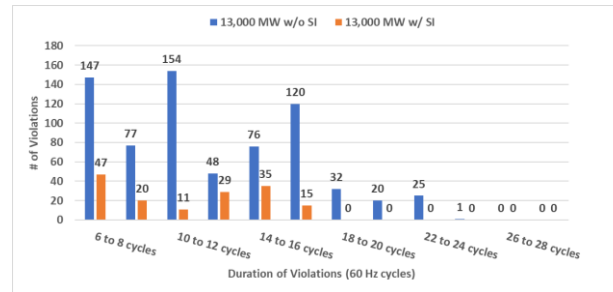
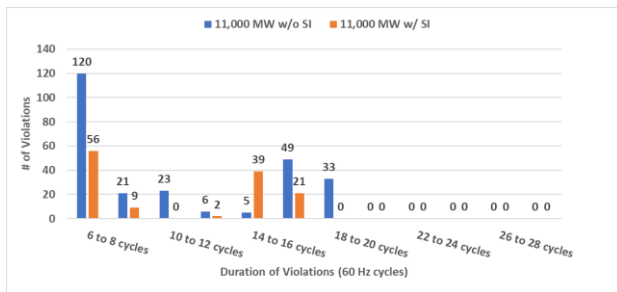

- >16 cycles 59.6 Hz violations are eliminated with the addition of SI
- # of violations remain about the same w/ SI at various IRG levels, while w/o SI they increase significantly as the IRG penetration increases

# Sensitivity 1: The location of adding SI

**SI** is added to locations with **different distances to the fault**

- **Bus voltage during the fault** is used as a **measure of the distance**: lower bus voltage during the fault indicates smaller electric distance to the fault.
- **P\_EXT\_11** is the only event considered since it is the only limiting event.

The following **three** case studies are performed:

1. **6000 MW penetration level, all PV with SI**: this is the threshold case
2. **Same case with LHFRT disabled**: LHFRT trips different PV units when different locations of PV/SI is considered. This case studies the impact of LHFRT.
3. **Zero-inertia case with SI installed on 5000 MW PV**: in this case, the locations of PV are the same across different scenarios.

# Sensitivity 1: 6000 MW penetration level, all PV with SI

- In this case study, the location of PVs and SI are changed at the same time while maintaining the 6000 MW penetration.

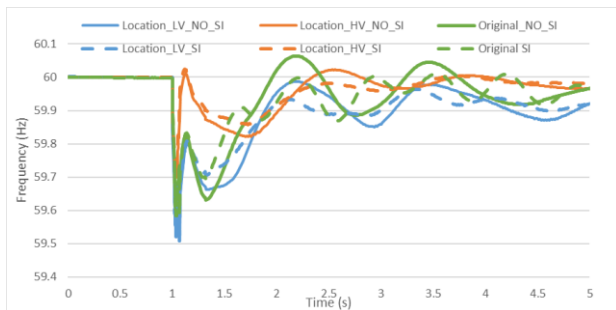

Average frequency of PG&E area.

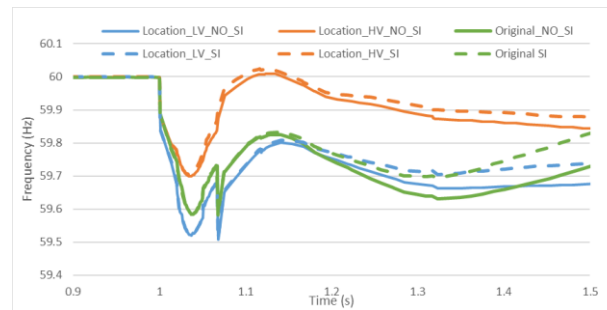

Ave. Freq. of PG&E area during 0.9 to 1.5 s.

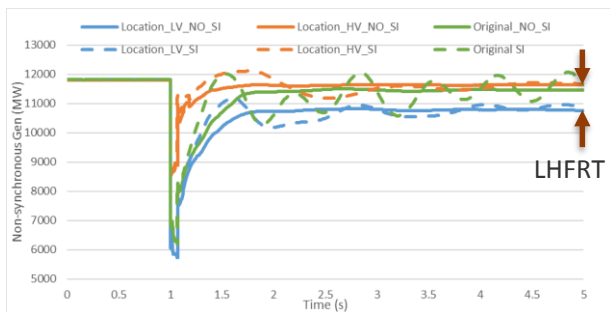

Non-synchronous generation of PG&E area.

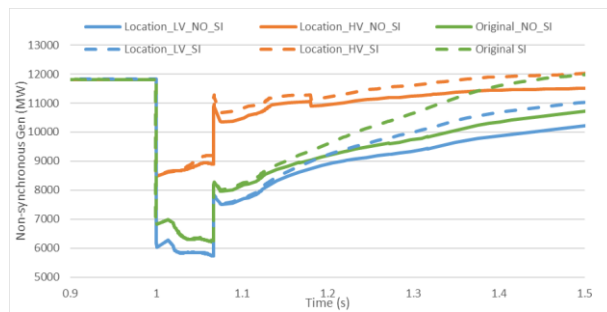

Non-synchronous generation of PG&E are during 0.9 to 1.5 seconds.

# Sensitivity 2- Changing Type of Resource providing SI

- **The 11,000 MW case is used to determine if SI on BESS can eliminate the 59.6 Hz criteria violations**
- **User-defined model of battery** is added  
“SI\_BESS.p”
- **Three cases are developed for the sensitivity study**
  - **Case A:** SI added to the existing BESS in the 11,000 MW case (771 MW of BESS)
  - **Case B:** Replace 3000 MW of newly added PV in case A with BESS and add SI to these. Remaining new PV (~3000 MW) also provide SI
  - **Case C:** Case B but with the reec\_c model parameters of the BESS IRGs made identical to those of the reec\_b models of the PV IRGs

# Sensitivity 2: Results

## Event: P\_EXT\_11

Summary of No. of Frequency Violations

	Violations of WECC frequency deviation criteria 59.6Hz			Lowest frequency (Hz)		
	PV-SI (Case A)	BESS_SI (Case B)	BESS_SI (Case C)	PV-SI	BESS_SI (Case B)	BESS_SI (Case C)
<b>6000 MW case</b>	96	82	96	57.597	57.648	57.579

Duration of Frequency Violations

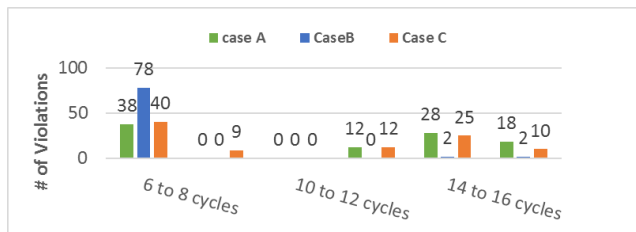

PV/battery output on Bus 35034

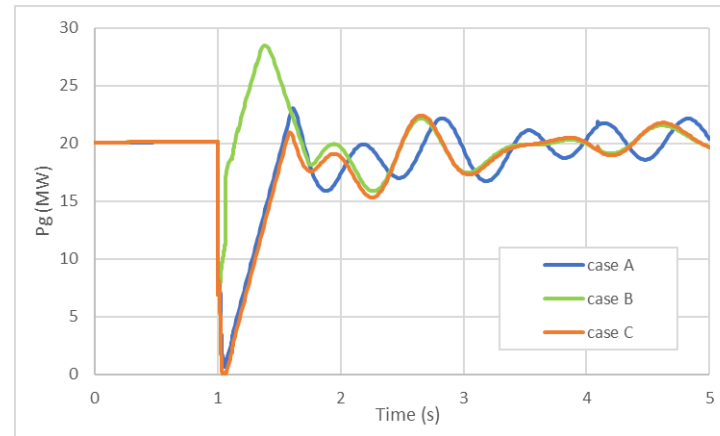



# Sensitivity 3: Changing PV IRGs Headroom

- Four head room values were simulated in the 11,000 MW case: 5%, 15%, 25% and 9900%
- ✓ The headroom was changed by changing the Pmax parameter of the reec\_b models
- The P\_EXT-11 contingency was simulated for these 4 headroom values
- All the violations in the SI threshold case could not be eliminated but with SI controller, the violations reduced from 200s to 100s

Case	# of 59.6 Hz Violations with no SI	# of 59.6 Hz Violations with SI
11,000 MW - 60% HR	257	127
11,000 MW - 5% HR	229	133
11,000 MW - 15% HR	243	106
11,000 MW - 25% HR	226	105
11,000 MW - 9900% HR	243	101

# Sensitivity 3: Changing PV IRGs Headroom

- Power output of non-synchronous generators and average frequency in PG&E are almost identical during and a short time after the fault at different headroom levels
- This is the reason why number of violations didn't vary much with different headroom values

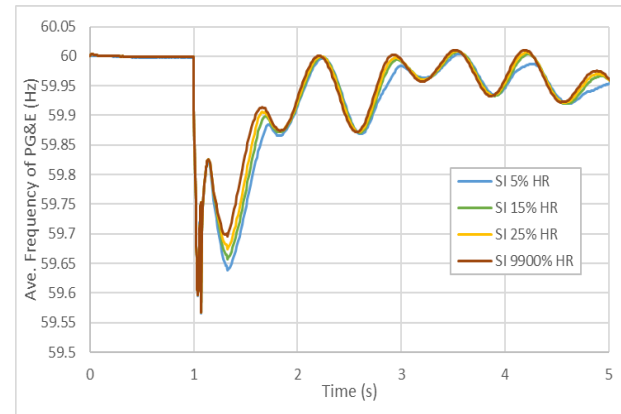
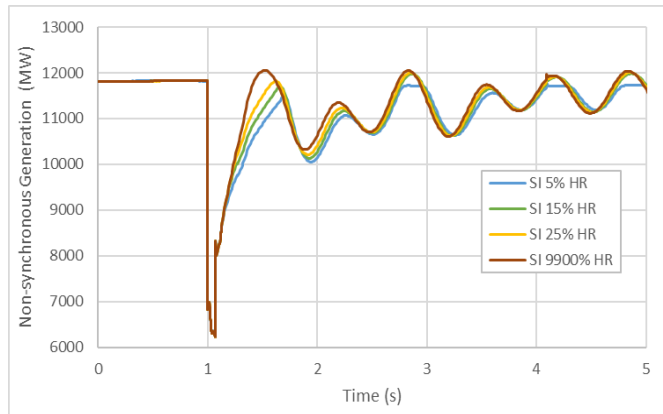

# Conclusions 1

- Synthetic Inertia Response controls **reduced** the **occurrence** and **severity** of frequency deviations but **did not eliminate them entirely**. They were not a 1:1 replacement of machine generation.
- Inverters close to faults are less effective for T system support due to local voltage collapse in those scenarios
  - Thus, a **geographical disperse portfolio** of assets is likely best suited for frequency response
- If SI is to be deployed on PV, the headroom needs to be co-optimized during the operation. The lost opportunity cost of PV not providing energy at MPPT needs to be evaluated but is out of the scope of this work
- On the other hand, battery is rarely operated at the maximum/minimum SoC and the flexible capacity is usually available. Unlike PV which is an energy resource, the battery is better suited to provide power services if there is a need for high power but low energy, such as frequency regulation and inertia support
- Voltage phase jumps during transients can result in erroneous frequency measurements and artificial frequency spikes, and depending on the filter delays the impact of such erroneous frequency dips may persist for some time. This problem is particularly acute in positive sequence dynamic simulators. Therefore, we may want to consider waiting for some time after the fault till the voltage recovers to a certain value before counting the number of 59.6 Hz criteria violations
  - ✓ Are terminal frequency measurements during transients really reflective of load generation imbalance?

# Conclusions 2

- The project proved that simulation methods are available to create low inertia transmission system scenarios, quantify inertia loss impacts, and test possible improvements to a reference penetration threshold.
  - Using frequency performance criteria to measure the magnitude of impact from disturbances before system recovery, simulations showed a reference threshold of 57% IRG (approx. 10GW out of 18GW) in PG&E territory while connected to the rest of the Western Interconnection (WI).
  - This is not a prediction of an expected future scenario, but rather a baseline performance value usable to show the effects of SIR.
  - California was not studied in electrical isolation from the WI which may provide a major source of connected inertia.

# Future Work

## Additional work is needed to better pinpoint future impacts, needs, and refined solutions

- Assess needs across scenarios of forecasted resource mixes
  - In the entire Western Interconnection
  - In California
- Determine how much headroom, from which synthetic inertia assets or alternatives, is needed
- Model the ensemble of controller methods, including refined inertial (SIR) control and others (FFR & PFR)
- Address modeling limitations of simulation tools around faults and frequency measurement
- Pursue a more complete protection coordination study, assessing different adaptation methods in T-connected and islanded modes.

# Thank you

---

[www.nrel.gov](http://www.nrel.gov)

Publication Number

This work was authored by the National Renewable Energy Laboratory, operated by Alliance for Sustainable Energy, LLC, for the U.S. Department of Energy (DOE) under Contract No. DE-AC36-08GO28308. **Funding provided by California Energy Commission's (CUC) Electric Program Investment Charge (EPIC) program managed by Pacific gas and Electric (PG&E) Company.** The views expressed in the article do not necessarily represent the views of the DOE or the U.S. Government. The U.S. Government retains and the publisher, by accepting the article for publication, acknowledges that the U.S. Government retains a nonexclusive, paid-up, irrevocable, worldwide license to publish or reproduce the published form of this work, or allow others to do so, for U.S. Government purposes.

