

# The Operational and Market Benefits of HVDC to System Operators

PRESENTED BY

Johannes P. Pfeifenberger (Brattle)  
Chandra Mohan Sonnathi (DNV)

PRESENTED AT

ESIG Fall Technical Workshop

OCTOBER 23, 2023



Source: Siemens

# Contents

---

1. Executive Summary
2. HVDC Technology
3. Case Studies of HVDC Transmission
4. HVDC Planning
5. Challenges to the Utilization of HVDC
6. Recommendation

This presentation is based on the report, [\*The Operational and Market Benefits of HVDC to System Operators\*](#), prepared with colleagues at [The Brattle Group](#) and [DNV](#) and input from industry participants. The [American Council on Renewable Energy \(ACORE\)](#), [GridLab](#), [Clean Grid Alliance](#), [Grid United](#), [Pattern Energy](#), and [Allete](#) commissioned the work.

## THE OPERATIONAL AND MARKET BENEFITS OF HVDC TO SYSTEM OPERATORS

### PREPARED BY

The Brattle Group  
Johannes P. Pfeifenberger  
Linquan Bai  
Andrew Levitt

### PREPARED FOR

GridLab  
American Council on Renewable Energy  
Clean Grid Alliance  
Grid United  
Pattern Energy  
Allete

### DNV

Cornelis A. Plet  
Chandra M. Sonnathi

SEPTEMBER 2023



Source: Siemens



# Executive Summary

---

## **HVDC transmission technology has evolved dramatically over the last 5-10 years**

- HVDC offers higher-capacity, longer-distance, lower-loss transmission on a smaller footprint than AC
- The development of voltage-sourced converter (VSC) technology has also offered dramatic improvements in HVDC capabilities
- These VSC-based capabilities are increasingly needed to enhance the existing AC grid

## **Internationally, approximately 50 GW of VSC-HVDC transmission projects are in operation today and approx. 130 GW planned or under development through the end of the decade**

- North America accounts for only 3% of all VSC systems in operation worldwide and (almost exclusively due to merchant developers) for approx. 30% of planned and proposed VSC systems

## **U.S. system operators less familiar with HVDC can benefit from the experience gained overseas (particularly in Europe) ... but significant planning, supply chain, operational, and regulatory challenges need to be addressed**

- The report provides a primer on HVDC technology, documents available capabilities and experience, addresses misconceptions, and offers recommendations to collaboratively address the identified challenges

# High Voltage Direct Current (HVDC) technology

A reliable and effective electrical power transmission solution since the late 1890s

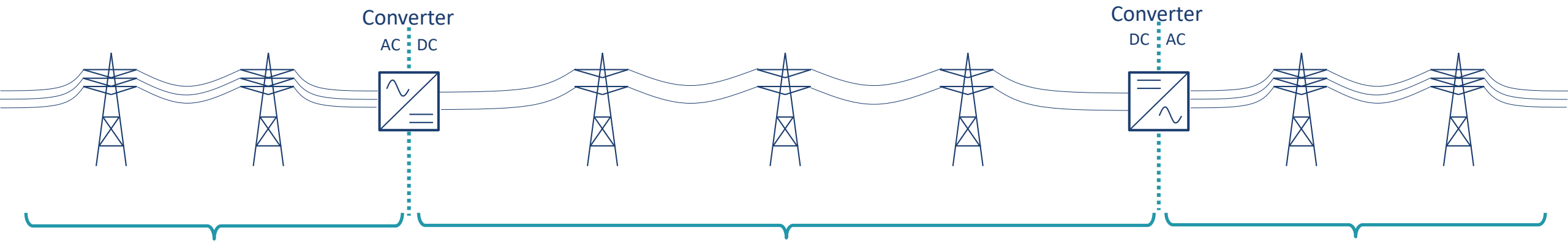

AC Voltage

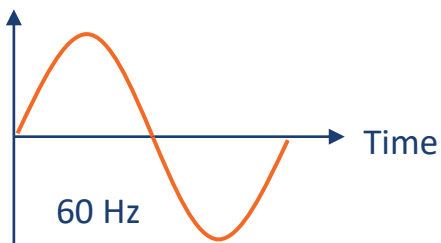

Alternating Current (AC)

DC Voltage

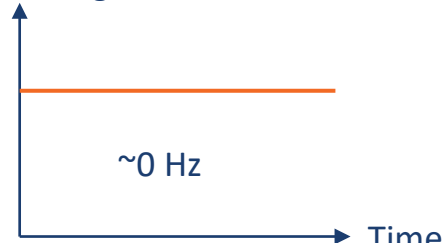

Direct Current (DC)

AC Voltage

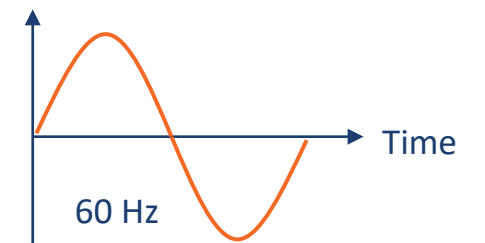

Alternating Current (AC)

- No reactive power** → Long distance transmission  
Overhead or underground
- No skin effect** → Optimal use of conductors
- Converters** → Power flow control / grid services

Less right of way = Smaller environmental and community impacts

# HVDC use cases

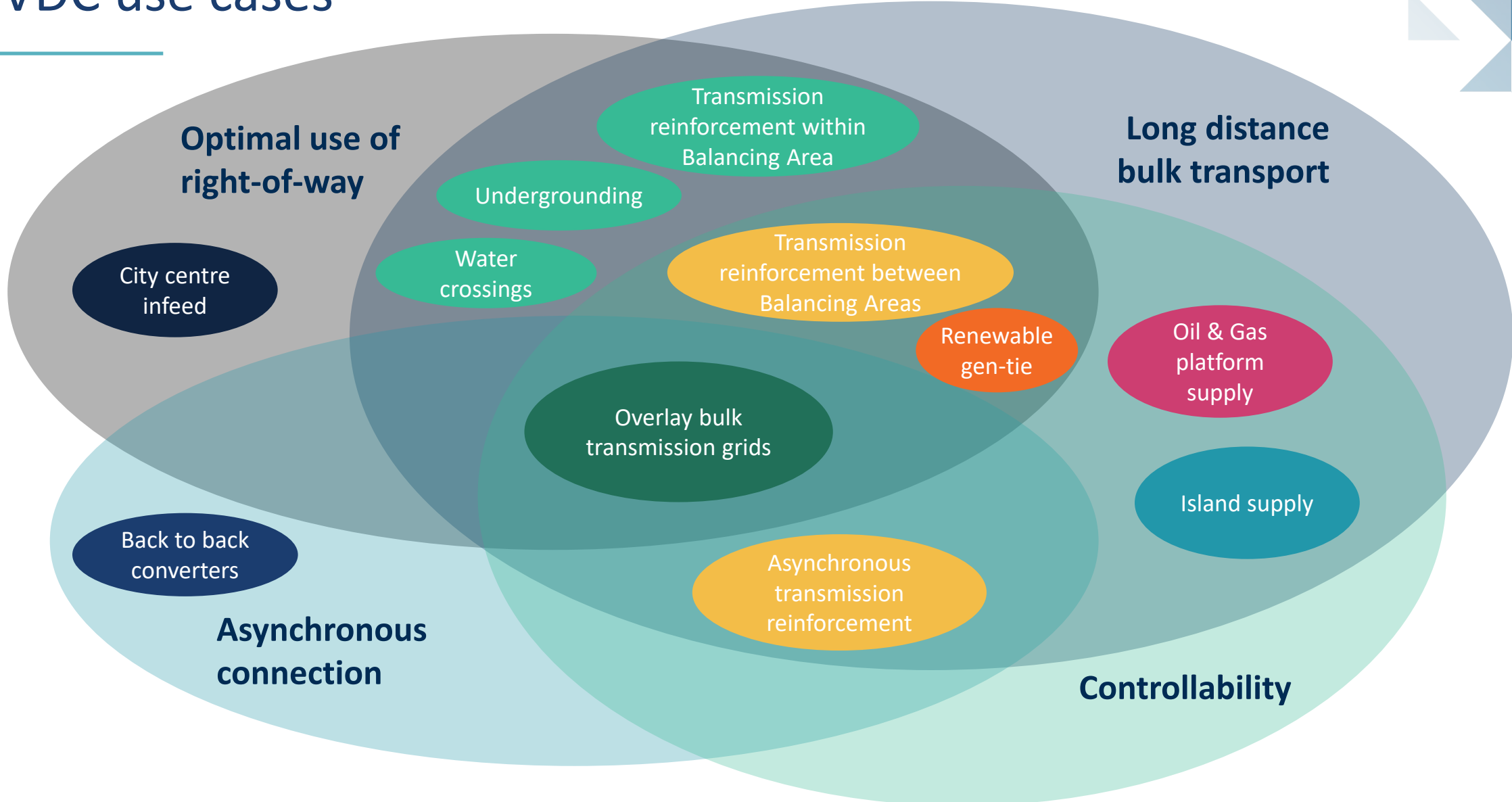

# A significant amount of experience exists

The majority of HVDC transmission capacity has been added in the last 5-10 years with more planned. Much of it is (or is planned to be) used to realize AC grid reinforcements

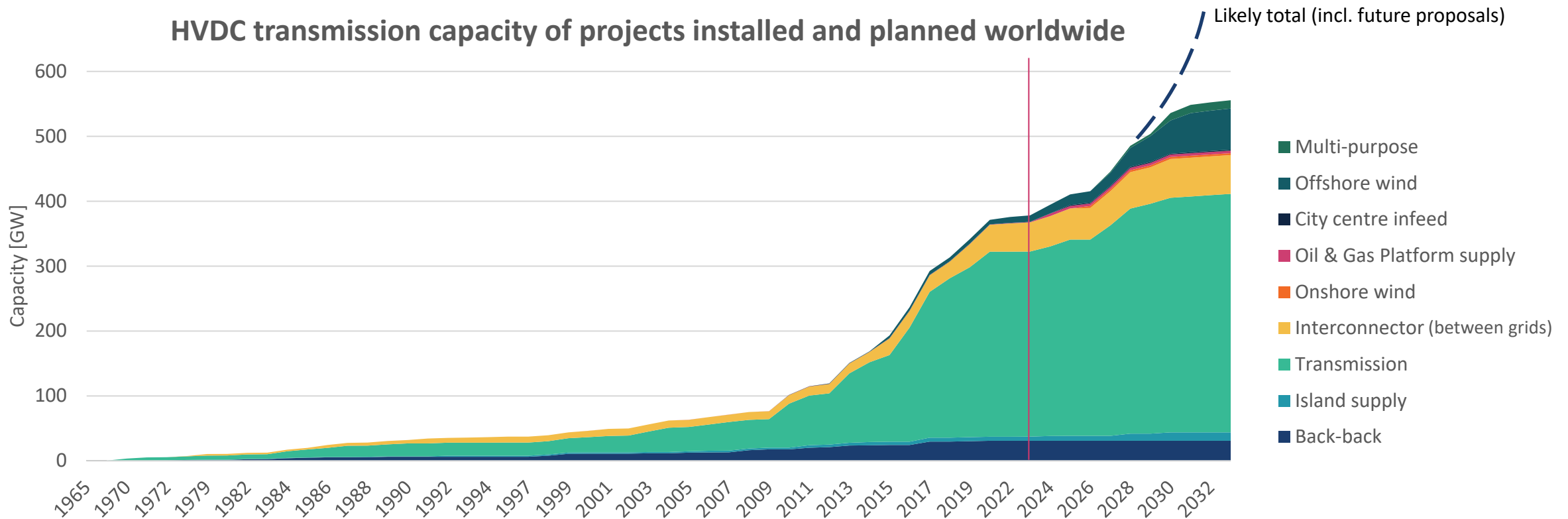

# HVDC converter technologies

Many different converter technologies exist, but growth is driven by **modular multi-level voltage source converter technology**

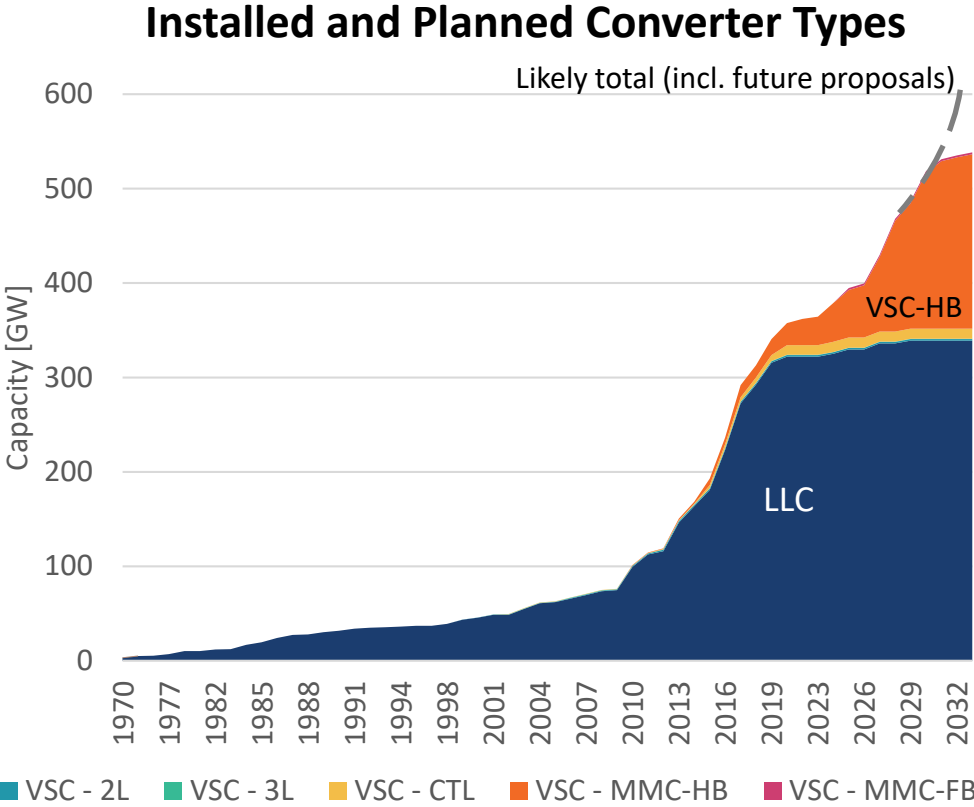
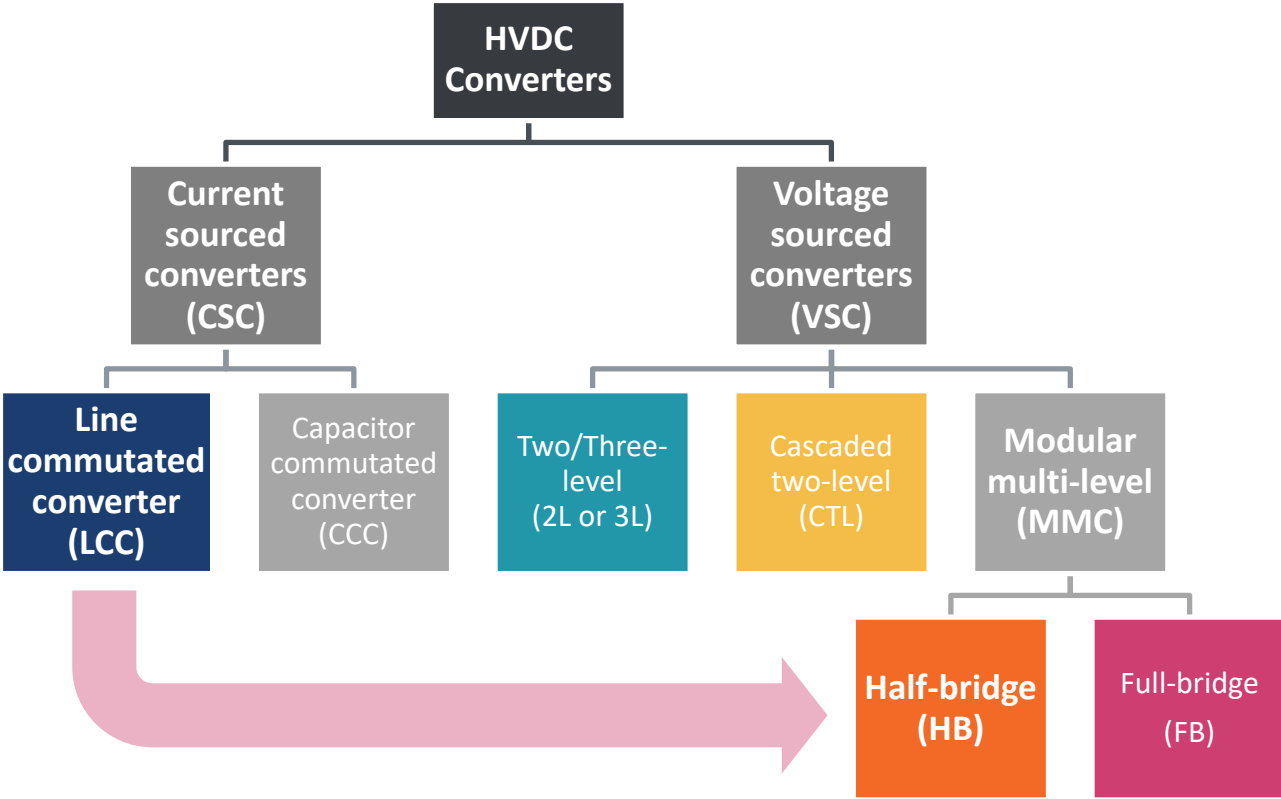

# Grid operation services (with VSC vs. LCC converters)

|                | Transmission functions   | Grid operations support  | Autonomous line dispatch                               | Power quality support                        | Contingency operations                                | Reliability & Market optimization   |
|----------------|--|--|--|--|---|---|
| Both LCC & VSC | Real power control<br>Reactive power control (static)                    | Synthetic inertia*<br>Frequency response<br>Regulation, ramping, spinning reserves | External Power (Tracking) Control<br>AC Line Emulation | Power oscillation damping                    | Run-back / run-up schemes<br>Emergency energy imports | AC grid power flow optimization<br>Resource adequacy, capacity imports<br>Intertie optimization |
| VSC only       | AC voltage and frequency control*<br>Weak and islanded grid connections* | Voltage support* / Reactive power control (dynamic)                                |  | AC phase balancing<br>AC harmonics filtering | Black-start and system restoration*                   | Frequent and rapid power flow reversal<br>Weak grid connections*                                |

\* Requires VSC converters capable of operating in grid-forming mode (but precise capabilities and requirements are evolving and specifications-dependent)



# HVDC Project Size and Commercial Readiness of HVDC Elements

## Commercial Readiness:

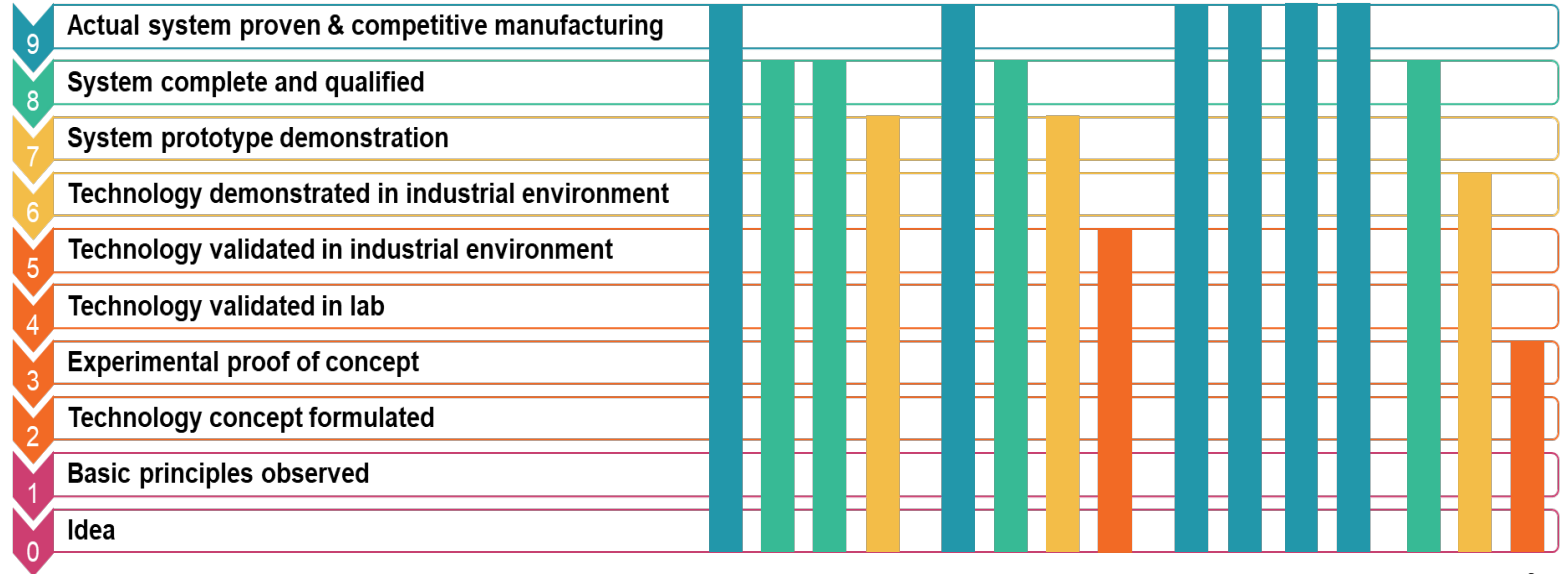

## VSC Project Size and Voltage:

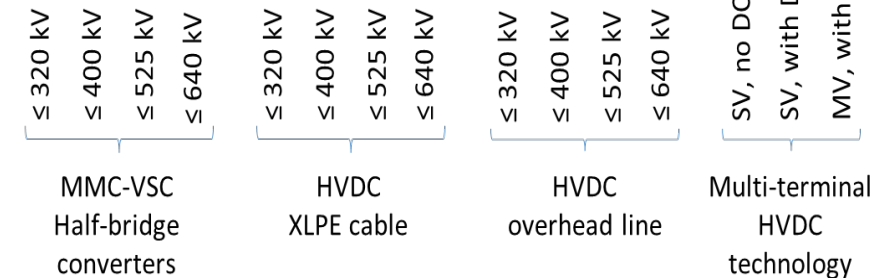
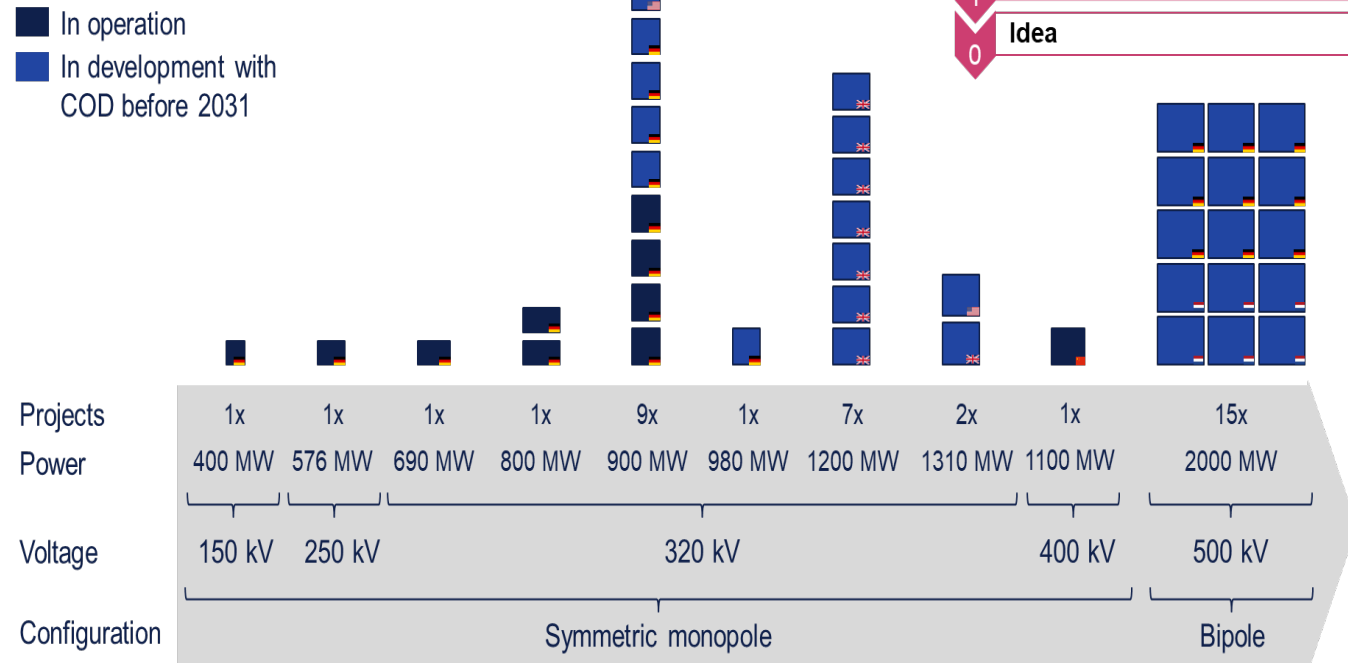

SV = single vendor  
 MV = multi-vendor

## Case studies of HVDC experience

---

**The report present 21 case studies of HVDC transmission experience in four areas of interest:**

- A. Experience with planning and procuring HVDC transmission overlays
- B. Experience with HVDC Transmission Planning in North America
- C. Operational experience with specific HVDC grid service capabilities
- D. Experience with regional and interregional HVDC market integration

(Only a subset of these case studies is summarized on the next slides)

# Germany's 10 GW of HVDC projects and 22 GW of procurements

## German grid operators are constructing major new HVDC lines designed to enhance the existing grid:

- 4 GW underground **SuedOstLink** project (2027)
- 2+2 GW underground **SuedLink** project (2028)
- 2 GW **multi-terminal** VSC HVDC link consisting of:
  - 2 GW **Ultraset** project, which converts one circuit of a multi-circuit AC overhead line to HVDC (2027)
  - 2 GW underground A-Nord link (2027)

## TenneT also announced its “Target Grid” HVDC overlay

- Already awarded €23 billion in contracts for 22 GW of HVDC systems, including fourteen pairs of standardized 2 GW 525kV HVDC converters

Note: Scottish & Southern Electricity Networks (SSEN) similarly procured five sets of 2 GW 525 kV HVDC systems to ensure delivery by 2030

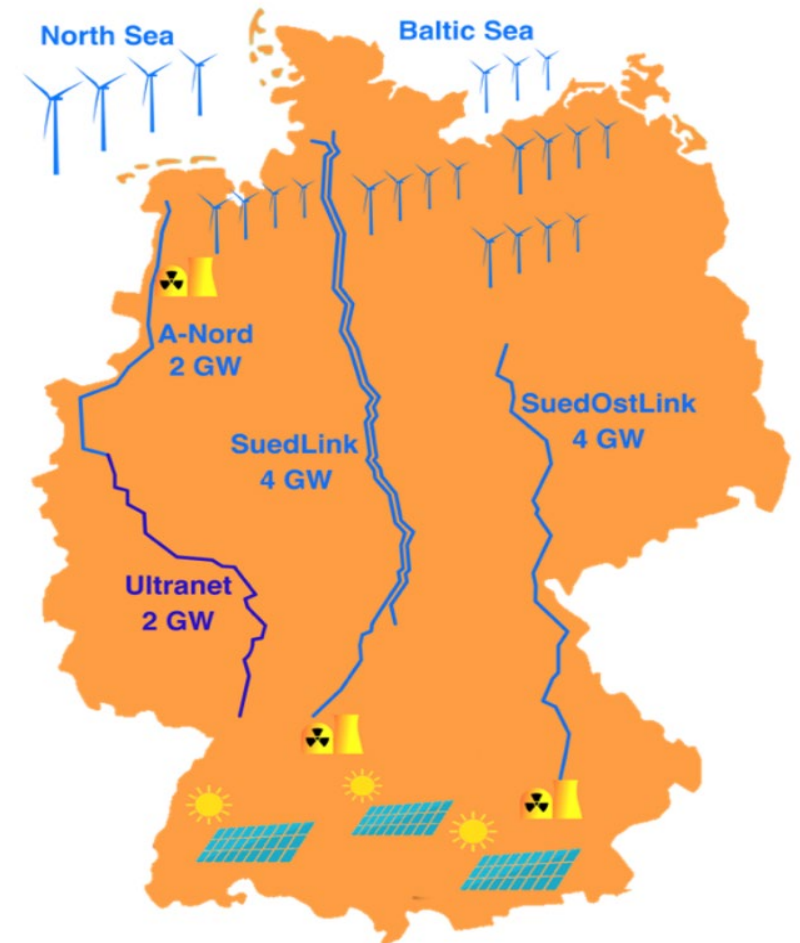

Source: INMR, [PD Measurements for HVDC Cable Projects](#), December 30, 2022.

# Terna's HVDC experience and "Hypergrid" proposal

## The Italian Grid operator, Terna, gained substantial experience with new HVDC technologies, including

- 500 kV, 600 MW 260-mile LCC-HVDC submarine cable between Montenegro and Italy
- 2 × 600 MW MW, 230-mile underground VSC-HVDC link between Italy and France
- Conversion of the aging 200 kV, LLC-based HVDC submarine multi-terminal link to utilize modern 400 MW VSC-HVDC technology
- The performance of the existing HVDC links has been satisfactory and Terna reports high availability of the converter equipment

## Based on lessons learned and positive operational experience, Terna committed to its €11 billion "Hypergrid":

- Existing onshore AC lines converted to high-capacity HVDC lines
- High-capacity HVDC submarine cables; and
- Additional AC grid upgrades

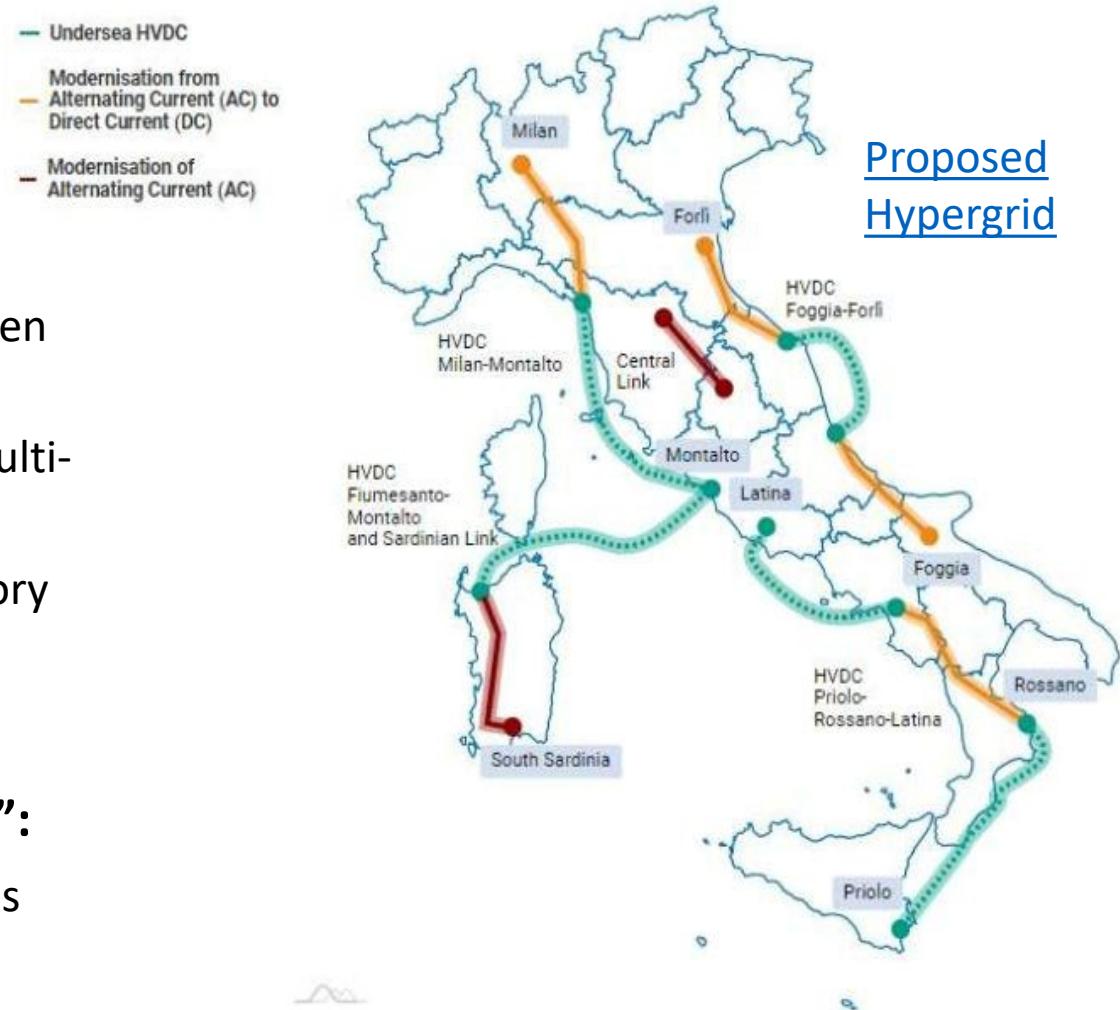

# Experience with specific HVDC capabilities

These examples show that significant experience exists with advanced AC grid support capabilities

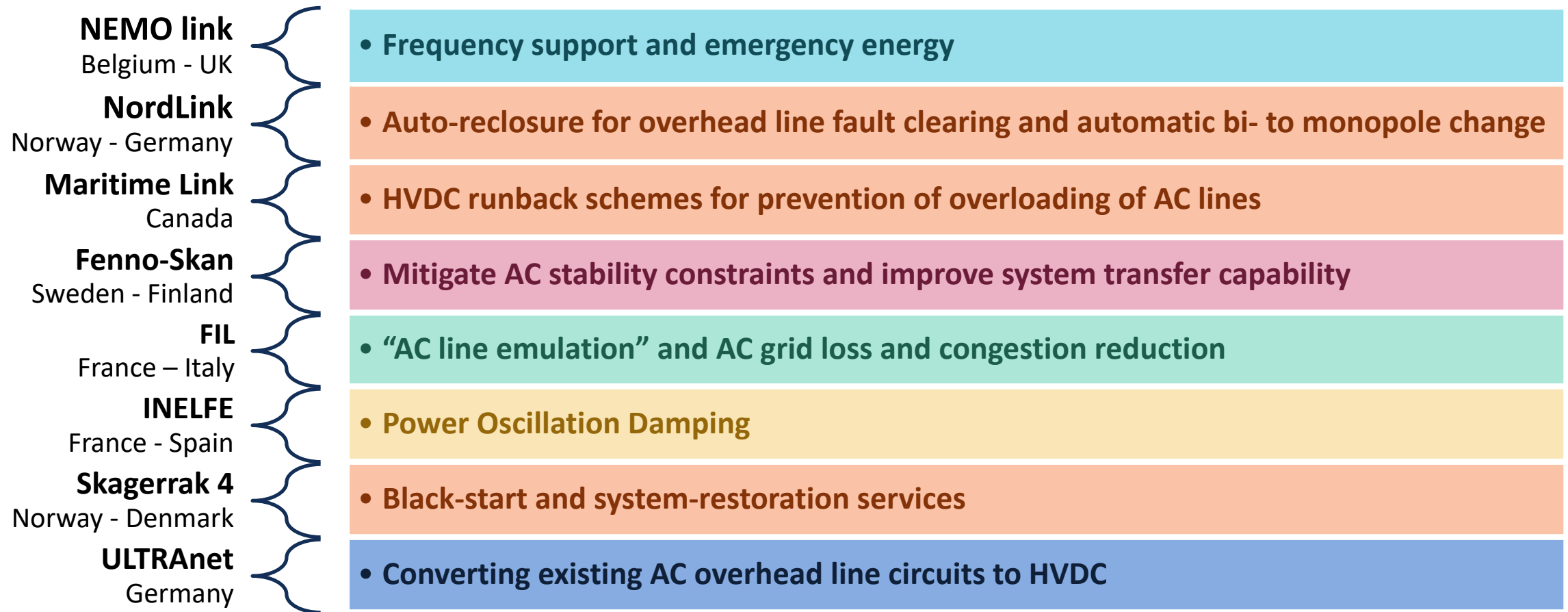

# Experience with HVDC transmission in North America

## North American HVDC Projects (Existing and Planned/Proposed)

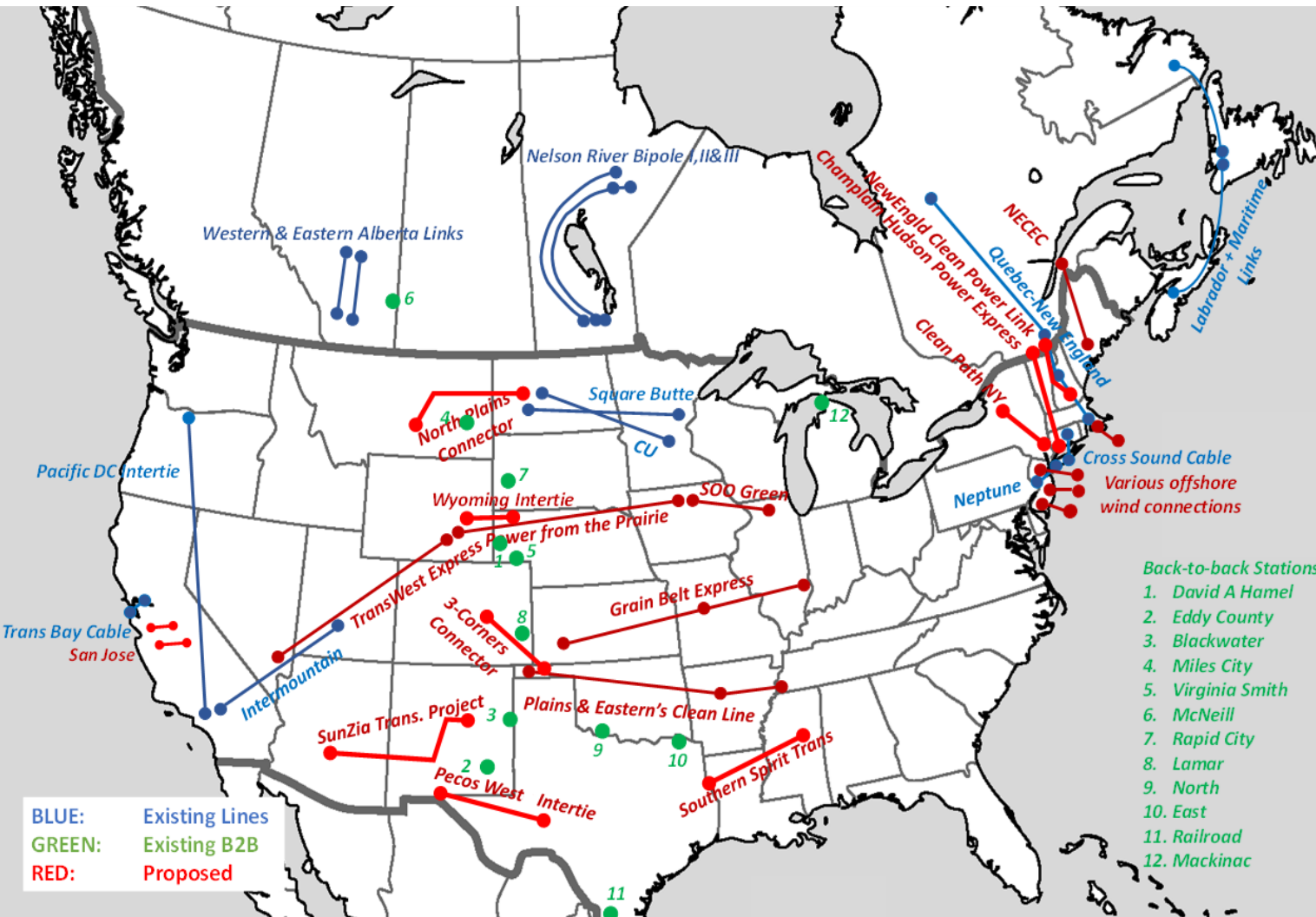

## CAISO leads the U.S. in planning and utilizing HVDC transmission:

- First VSC-MMC HVDC line (TransBay, 2013)
- 10 VSC-HVDC systems evaluated in transmission planning; 2 approved
- Full co-optimization of HVDC transmission with generation in day-ahead and real-time markets since 2017
- Interregional optimization in WEIM
- Subscriber PTO proposal (merchant lines)

**Most U.S. HVDC transmission projects proposed by merchant and OSW developers (not system operators)**

# HVDC transmission studies

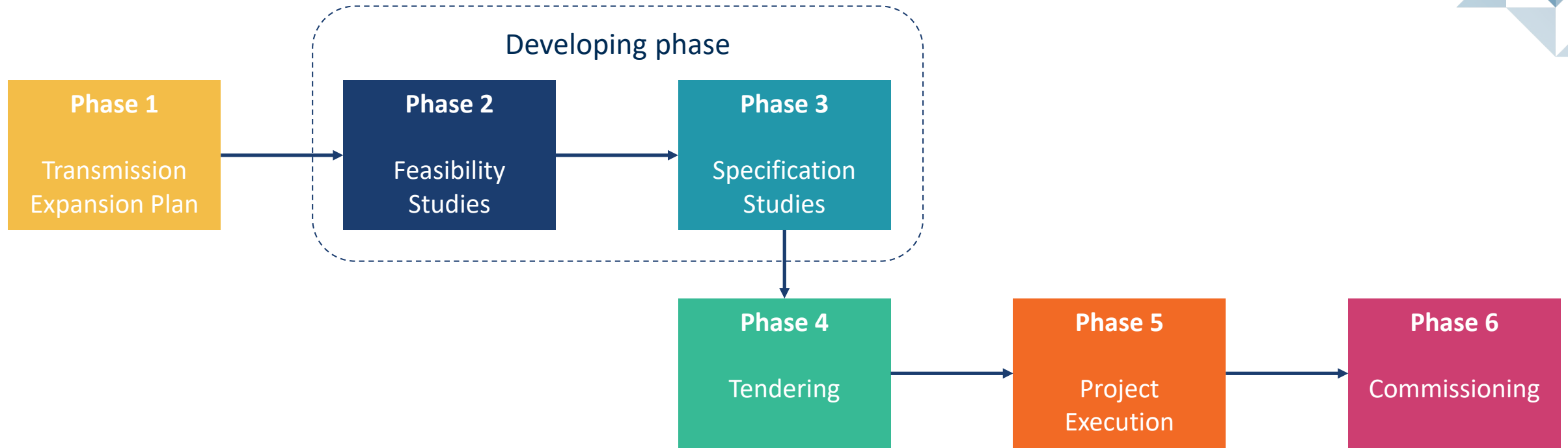

- **IEEE HVDC & FACTS Subcommittee report (PES-TR86):** how relevant studies in each planning phase should evaluate HVDC projects, including in each of the shown six planning and project development phases. System operators and owners will need to be involved in all study phases shown.

# HVDC transmission studies (cont'd)

**Similar to AC transmission planning:** HVDC systems need to be analyzed through a number of studies, sequentially adding more detail, scope, system performance, model fidelity, and temporal granularity

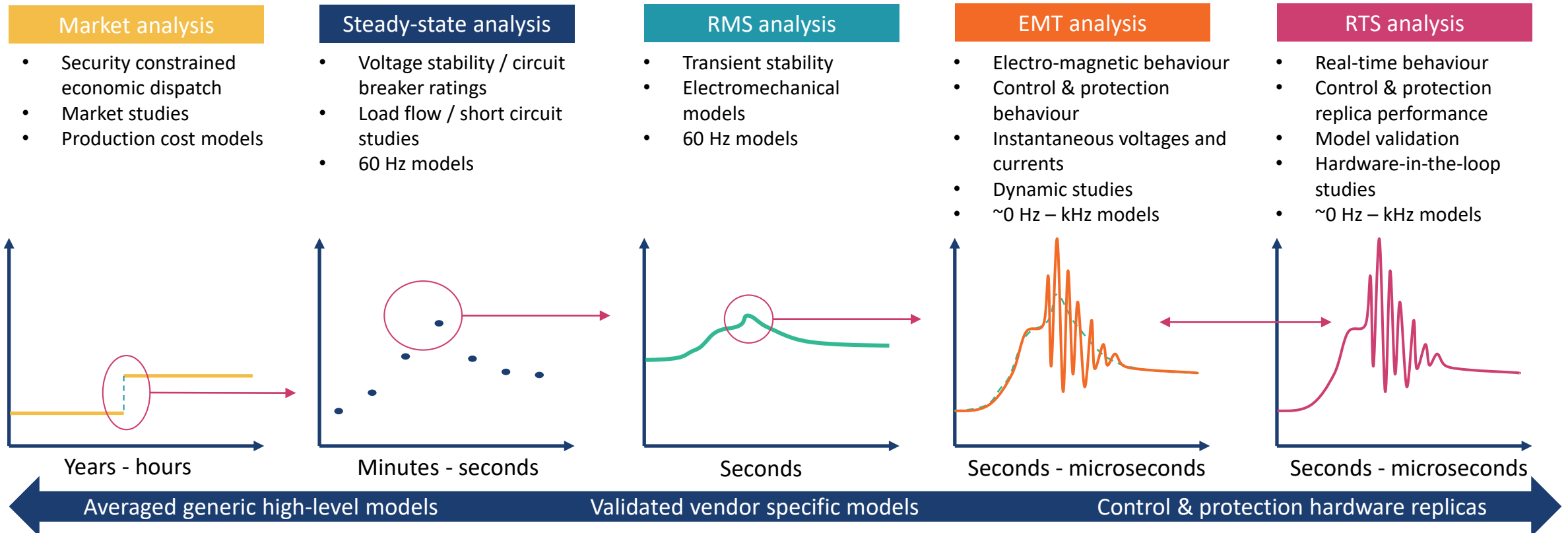



# Considering & quantifying HVDC benefits in transmission planning

| HVDC-VSC Capability  | Planning Benefits / Options for Quantification  |
|--|---|
| 1. Flow control/market optimization  | <ul style="list-style-type: none"> <li>• Estimate value of congestion relief and loss reduction on AC grid with nodal production cost model that can optimize HVDC</li> </ul>   |
| 2. Dynamic reactive power and voltage control  | <ul style="list-style-type: none"> <li>• Avoided cost of STATCOMs, SVCs or synchronous condensers</li> </ul>  |
| 3. Lower long-distance transfer losses   | <ul style="list-style-type: none"> <li>• Market value of avoided losses on transmitted energy</li> </ul>  |
| 4. Smaller footprint/right-of-way (ROW), including for undergrounding option                     | <ul style="list-style-type: none"> <li>• Lower cost for right-of-way (e.g., 50ft less than for 765kV AC); lower cost of undergrounding; lower permitting risks</li> </ul>   |
| 5. Reliability benefits (fault ride-through, lower N-1 contingency for bipoles, voltage support) | <ul style="list-style-type: none"> <li>• Increased transfer capacity; reduced cost of contingency reserves; avoided AC equipment costs (e.g., additional lines, STATCOMs)</li> </ul>  |
| 6. AC dynamic stability; power oscillation dampening; mitigate stability constraints on AC grid  | <ul style="list-style-type: none"> <li>• Avoided cost of power system stabilizers/supplemental power oscillation damping (POD) controllers on batteries, SVCs, STATCOMs, switched shunt equipment, synchronous condensers, etc.</li> <li>• Value of congestion relief on proxy constraints</li> </ul> |
| 7. Grid forming, grid services, synthetic inertia, blackstart/restoration, etc.                  | <ul style="list-style-type: none"> <li>• Market value or avoided cost of providing the grid services through conventional means</li> </ul>  |

# Common misconceptions about modern HVDC technology

VSC technology is not yet sufficiently mature

VSC converters have lower reliability and availability

VSC converters have high losses

Placing VSC-HVDC converters from different vendors close to one another is not reliable

VSC-HVDC technology is not suitable for overhead transmission lines

HVDC power electronic switches cannot handle the surge voltages from lightning strikes

MMC-VSC HVDC systems cannot handle overhead line faults

HVDC transmission systems have no overload capability

VSC-HVDC converters have the same fault-related issues as legacy inverters, such as “momentary cessation”

Inverter-based resources, such as HVDC, cannot provide black-start services because of large in-rush currents

HVDC circuit breakers do not yet exist

HVDC technology is “more complicated”

# Overview and Examples of HVDC-Related Training

| Topic                                     | Audience   | Specificity  | Trainer   | Examples  |
|---|--|--|---|---|
| <b>HVDC technology &amp; systems</b>      | System planners, technologists, project engineers, researchers | Generic, could be focused on different technology groups, or systems | Consultants, universities, industry associations, vendors, etc. | <ul style="list-style-type: none"> <li>• <a href="#">HVDC Converter Technologies training course (dnv.com)</a></li> <li>• <a href="#">Training – The National HVDC Centre</a></li> <li>• <a href="#">Services - TransGrid Solutions (myftpupload.com)</a></li> </ul>                    |
| <b>HVDC modelling &amp; analysis</b>      | System planners, project engineers, researchers                | Generic  | Consultants, universities, industry associations, vendors,...   | <ul style="list-style-type: none"> <li>• <a href="#">Training &amp; Support - RTDS Technologies</a></li> <li>• <a href="#">HVDC Control &amp; Project Management   PSCAD</a></li> <li>• <a href="#">HVDC-VSC System Training - RTE international (rte-international.com)</a></li> </ul> |
| <b>HVDC project management</b>            | Project teams  | Generic  | Consultants, industry associations, vendors,...                 |   |
| <b>HVDC operation (operator training)</b> | Grid Operators   | Vendor specific  | Vendors, consultants,...  | <ul style="list-style-type: none"> <li>• <a href="#">Training   Hitachi Energy</a></li> <li>• <a href="#">High Voltage Direct Current (HVDC) Systems e-learning – GE Grid Solutions</a></li> </ul>  |
| <b>HVDC maintenance</b>                   | Maintenance teams  | Vendor specific  | Vendors, consultants,...  |   |
| <b>Market operations</b>                  | Market Operators   | TSO specific   | TSO, market operator, consultants                               | <ul style="list-style-type: none"> <li>• <a href="#">Controllable Lines Proposal (nyiso.com)</a></li> </ul>   |

# Challenges to the utilization of HVDC capabilities

---

## **Outdated, incomplete and uncoordinated technical standardization**

- Existing standards do not fully take into account characteristics of modern HVDC transmission technology.
  - ▶ MMC-VSC converter technology
  - ▶ Underground and submarine HVDC cable technology
- Some ongoing standardization initiatives are overtly conservative and reduce ability to realize VSC-HVDC benefits
- Existing standards do not cover all HVDC applications
  - ▶ IEEE P2800 does not cover offshore converter AC performance requirements
  - ▶ No operational guideline for DC grid behavior
- HVDC standardization is not coordinated across regions and between functional disciplines
  - ▶ Health, safety, and environment
  - ▶ System performance and design
  - ▶ Technology & equipment (to ensure modularity and compatibility)
  - ▶ Test, measurement, & analysis
  - ▶ Communication and Cyber security

# Challenges to the utilization of HVDC capabilities (cont'd)

---

## Supply chain challenges

- Small number of HVDC suppliers
- Limited production capacity of the vendor in terms of engineering staff, number of production lines, limited transport and installation equipment, availability of testing facilities
- Technical maturity of the vendors' HVDC technology
- Project management experience of the vendor
- Country of origin of the vendor and the resulting export restrictions
- Sub-supplier/partnership strategy of vendors

## Planning, regulatory, and market-design challenges

- Lack of proactive, multi-value planning processes that are able to capture long-term HVDC-related values
- Lack of grid codes to ensure that system operators are able to take advantage of the technology's grid-supporting HVDC capabilities
- Limited operator experience
- Lack of market-clearing software able to co-optimize generation and controllable HVDC transmission facilities

# Recommendations: near-term priorities

---

1. Develop and implement “grid codes” for interconnected/embedding HVDC lines (as ENTSO-E has done) that allow grid operators to take full advantage of modern HVDC capabilities
2. Adapt grid planning tools and multi-value transmission planning frameworks to take full account of modern HVDC capabilities
3. Provide training for planning, engineering, and grid operations staff so they are able to take advantage of modern HVDC capabilities (rather than being focused solely on preventing problems that might be encountered)
4. Address current supply chain challenges by building manufacturing capability through clear long-term commitments
5. Develop standardized HVDC functional and interface requirements, and vendor compatibility standards, taking advantage of experience gained in similar European efforts
6. Develop new regulatory and cost-recovery paradigms that can take advantage of the controllable nature of HVDC technology (both regionally and inter-regionally), including merchant transmissions to permit greater competition and allow for more financial risk sharing with transmission owners

# Recommendations: longer-term priorities

---

7. Update grid operations to be able to take full advantage of HVDC grid-service capabilities
8. Update market designs so system operators can co-optimize controllable transmission with generation
9. Implement optimization of interregional transmission capabilities that can accommodate merchant HVDC transmission

**To implement these recommendations and address the identified challenges, grid operators and planning authorities should collaborate with:**

- Transmission owners/developers
- HVDC equipment manufacturers
- North American Electric Reliability Corporation (NERC)
- Industry groups, regulators, and states
- U.S. Department of Energy (DOE) and its National Labs



Thank You!

Comments and Questions?





# About the Speakers

---



**Johannes P. Pfeifenberger**

**PRINCIPAL  
THE BRATTLE GROUP, BOSTON**

[Hannes.pfeifenberger@brattle.com](mailto:Hannes.pfeifenberger@brattle.com)

+1.617.234.5624

[\(webbio and publications\)](#)

**Johannes (Hannes) Pfeifenberger**, a Principal at The Brattle Group, is an economist with a background in electrical engineering and over twenty-five years of experience in wholesale power market design, renewable energy, electricity storage, and transmission. He also is a Visiting Scholar at MIT’s Center for Energy and Environmental Policy Research (CEEPR), a former Senior Fellow at Boston University’s Institute of Sustainable Energy (BU-ISE), a IEEE Senior Member, and currently serves as an advisor to research initiatives by the U.S. Department of Energy, the National Labs, and the Energy Systems Integration Group (ESIG).

Hannes specializes in wholesale power markets and transmission. He has analyzed transmission needs, transmission benefits and costs, transmission cost allocations, and renewable generation interconnection challenges for independent system operators, transmission companies, generation developers, public power companies, industry groups, and regulatory agencies across North America. He has worked on transmission matters in SPP, MISO, PJM, New York, New England, ERCOT, CAISO, WECC, and Canada and has analyzed offshore-wind transmission challenges in New York, New England, and New Jersey.

He received an M.A. in Economics and Finance from Brandeis University’s International Business School and an M.S. and B.S. (“Diplom Ingenieur”) in Power Engineering and Energy Economics from the University of Technology in Vienna, Austria.

# About the Speakers

---



**Chandra M Sonnathi**

**HVDC SPECIALIST  
DNV, DALLAS**

[Chandra.mohan.sonnathi@dnv.com](mailto:Chandra.mohan.sonnathi@dnv.com)

+1.469. 678. 0716

**Chandra Mohan Sonnathi** is lead HVDC specialist in **DNV's** power systems advisory group. He is an experienced power engineer with a master's degree in power systems from the National Institute of Technology, Trichy, India.

He has over 15 years of experience in the HVDC industry and has worked for ABB and General Electric (GE) in various roles, where he focused on HVDC lead engineering, risk and opportunity strategy and mitigation, overall HVDC system solution development.

Chandra has authored several patent applications in the HVDC area, is an IET UK Fellow, IEEE USA senior member, and BSI UK National HVDC committee member. Prior to joining DNV, he supported European TSO TenneT in developing the world's first 2GW 525 kV offshore grid connection system.

# Brattle Group Publications on Transmission

Pfeifenberger, Bay, et al., [The Need for Inertie Optimization: Reducing Customer Costs, Improving Grid Resilience, and Encourage Interregional Transmission](#), October 2023.

Pfeifenberger, Plet, et al., [The Operational and Market Benefits of HVDC to System Operators](#), for GridLab, ACORE, Clean Grid Alliance, Grid United, Pattern Energy, and Allete, September 2023.

Pfeifenberger, DeLosa, et al., [The Benefit and Urgency of Planned Offshore Transmission](#), for ACORE, ACP, CATF, GridLab, and NRDC, January 24, 2023.

Brattle and ICC Staff, [Illinois Renewable Energy Access Plan: Enabling an Equitable, Reliable, and Affordable Transition to 100% Clean Electricity for Illinois](#), December 2022.

Pfeifenberger et al., [New Jersey State Agreement Approach for Offshore Wind Transmission: Evaluation Report](#), October 26, 2022.

Pfeifenberger, DeLosa III, [Transmission Planning for a Changing Generation Mix](#), OPSI 2022 Annual Meeting, October 18, 2022.

Pfeifenberger, [Promoting Efficient Investment in Offshore Wind Transmission](#), DOE-BOEM Atlantic Offshore Wind Transmission Economics & Policy Workshop, August 16, 2022.

Pfeifenberger, [Generation Interconnection and Transmission Planning](#), ESIG Joint Generation Interconnection Workshop, August 9, 2022.

Pfeifenberger and DeLosa, [Proactive, Scenario-Based, Multi-Value Transmission Planning](#), Presented at PJM Long-Term Transmission Planning Workshop, June 7, 2022.

Pfeifenberger, [Planning for Generation Interconnection](#), Presented at ESIG Special Topic Webinar: Interconnection Study Criteria, May 31, 2022.

RENEW Northeast, [A Transmission Blueprint for New England](#), Prepared with Borea and The Brattle Group, May 25, 2022.

Pfeifenberger, [New York State and Regional Transmission Planning for Offshore Wind Generation](#), NYSERDA Offshore Wind Webinar, March 30, 2022.

Pfeifenberger, [The Benefits of Interregional Transmission: Grid Planning for the 21st Century](#), US DOE National Transmission Planning Study Webinar, March 15, 2022.

Pfeifenberger, [21st Century Transmission Planning: Benefits Quantification and Cost Allocation](#), for NARUC members of the Joint Federal-State Task Force on Electric Transmission, January 19, 2022.

Pfeifenberger, Spokas, Hagerty, Tsoukalis, [A Roadmap to Improved Interregional Transmission Planning](#), November 30, 2021.

Pfeifenberger, Tsoukalis, Newell, [“The Benefit and Cost of Preserving the Option to Create a Meshed Offshore Grid for New York,”](#) Prepared for NYSERDA with Siemens and Hatch, November 9, 2022.

Pfeifenberger, [Transmission—The Great Enabler: Recognizing Multiple Benefits in Transmission Planning](#), ESIG, October 28, 2021.

Pfeifenberger et al., [Transmission Planning for the 21st Century: Proven Practices that Increase Value and Reduce Costs](#), Brattle-Grid Strategies, October 2021.

Pfeifenberger et al., [Initial Report on the New York Power Grid Study](#), prepared for NYPSC, January 19, 2021.

Van Horn, Pfeifenberger, Ruiz, [“The Value of Diversifying Uncertain Renewable Generation through the Transmission System,”](#) BU-ISE, October 14, 2020.

Pfeifenberger, Newell, Graf and Spokas, [“Offshore Wind Transmission: An Analysis of Options for New York”](#), prepared for Anbaric, August 2020.

Pfeifenberger, Newell, and Graf, [“Offshore Transmission in New England: The Benefits of a Better-Planned Grid,”](#) prepared for Anbaric, May 2020.

Tsuchida and Ruiz, [“Innovation in Transmission Operation with Advanced Technologies,”](#) T&D World, December 19, 2019.

Pfeifenberger, [“Cost Savings Offered by Competition in Electric Transmission,”](#) Power Markets Today Webinar, December 11, 2019.

Chang, Pfeifenberger, Sheilendranath, Hagerty, Levin, and Jiang, [“Cost Savings Offered by Competition in Electric Transmission: Experience to Date and the Potential for Additional Customer Value,”](#) April 2019 and [“Response to Concentric Energy Advisors’ Report on Competitive Transmission,”](#) August 2019.

Ruiz, [“Transmission Topology Optimization: Application in Operations, Markets, and Planning Decision Making,”](#) May 2019.

Chang, Pfeifenberger, [“Well-Planned Electric Transmission Saves Customer Costs: Improved Transmission Planning is Key to the Transition to a Carbon-Constrained Future,”](#) WIRES&Brattle, June 2016.

Newell et al. [“Benefit-Cost Analysis of Proposed New York AC Transmission Upgrades,”](#) on behalf of NYISO and DPS Staff, September 15, 2015.

Pfeifenberger, Chang, and Sheilendranath, [“Toward More Effective Transmission Planning: Addressing the Costs and Risks of an Insufficiently Flexible Electricity Grid,”](#) WIRES and Brattle, April 2015.

Chang, Pfeifenberger, Hagerty, [“The Benefits of Electric Transmission: Identifying and Analyzing the Value of Investments,”](#) on behalf of WIRES, July 2013.

Chang, Pfeifenberger, Newell, Tsuchida, Hagerty, [“Recommendations for Enhancing ERCOT’s Long-Term Transmission Planning Process,”](#) October 2013.

Pfeifenberger and Hou, [“Seams Cost Allocation: A Flexible Framework to Support Interregional Transmission Planning,”](#) on behalf of SPP, April 2012.

Pfeifenberger, Hou, [“Employment and Economic Benefits of Transmission Infrastructure Investment in the U.S. and Canada,”](#) on behalf of WIRES, May 2011.